



INSTRUCTION MANUAL

WIRELESS ACCESS POINT **AP-12**



Icom Inc.

BEFORE INSTALLATION	1
OBTAINING AN IP ADDRESS FROM THE DHCP SERVER	2
FIXED IP ADDRESS SETTING	3
AP-12 MANAGER	4
SETTING EXAMPLES	5
IP CONFIGURATION	6
REFERENCES	7

IMPORTANT

When connecting the AP-12 to a bridging type modem (or in bridging mode) directly, a global IP address may be assigned to the AP-12 from the modem, according to the modem settings. When a global IP address is assigned to the AP-12, an illegal operator, such as a cracker, a hacker, may access it. To avoid such access, connect a router between the modem and the AP-12.

The bridge type modem assigns a global IP address to the connected PC (only one).

The router type modem assigns a private IP address (e.g. 192.168.x.x) to the connected PCs via the HUB by the built-in routing function. The AP-12 can be connected to a router type modem directly.

Contact your Internet Service Provider (ISP) if you do not know your modem type.

About exchanging the AP-12 or the PC connected to the AP-12.

The AP-12 memorizes the communication settings between the AP-12 and the connected PC. Thus, if the AP-12 and/or the PC connected to it changed, communication may fail.

In such case, turn the AP-12 power OFF. After waiting a few seconds, turn the power ON again.

INTRODUCTION

FOREWORD

Thank you for purchasing the Icom Wireless Access point AP-12.

This wireless access point is provided with the functions necessary for supporting a wireless LAN.

This manual is designed to help you use the product to its fullest potential. Read this manual carefully before using the product.

TRADEMARK CREDITS

Icom, Icom Inc. and the  logo are registered trademarks of Icom Incorporated (Japan) in the United States, the United Kingdom, Germany, France, Spain, Russia and/or other countries.

Windows is a registered trademark of Microsoft Corporation in the United States and/or other countries.

The screen shots that appear in this manual are used with permission of Microsoft Corporation.

Other product and company names mentioned herein are trademarks or registered trademarks of their respective owners.

FEATURES

- ◎ Up to 11 Mbps data transmission rate with automatic fallback function (11/5.5/2/1 Mbps).
- ◎ The supplied utility software, [AP-12 Manager] allows you simple setup of the system with a step-by-step tutorial. **Windows XP, Windows Me, Windows 98SE, Windows 98, Windows 2000** are supported.
- ◎ The diversity antenna is built into the compact body to provide stable communication.
- ◎ Versatile operating modes for Access Point mode, Bridge mode A (Peer-to-Peer), Bridge mode B (Client mode), and Bridge mode C (Multi-site). A roaming function is also available while in Access Point mode. It provides full mobility and seamless network access from anywhere within the area for the connected clients.
- ◎ The DHCP client function is available to automatically obtain the network configuration such as the IP address (This is not activated in Bridge mode B mode operation).
- ◎ Data can be protected with high-level security function such as 128/64-bit WEP (Wired Equivalent Privacy) encryption and MAC address registration.
- ◎ AP-12 uses a direct spread-spectrum communication system which ensures stabilized communication even under influence of noise and interference.

INTRODUCTION

FCC INFORMATION

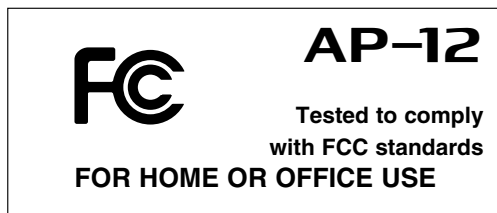

CAUTION: Changes or modifications not expressly approved by Icom Inc. could void the user's authority to operate this Access Point.

Class B digital device users;

This equipment has been tested and found to comply with the limits for a Class B digital device, pursuant to Part 15 of the FCC Rules. These limits are designed to provide reasonable protection against harmful interference in a residential installation. This equipment generates, uses, and can radiate radio frequency energy and, if not installed and used in accordance with the instruction manual, may cause harmful interference to radio communications. However, there is no guarantee that interference will not occur in a particular installation. If this equipment does cause harmful interference to radio or television reception, which can be determined by turning the equipment off and on, the user is encouraged to try to correct the interference by one or more of the following measures:

- Reorient or relocate the receiving antenna.
- Increase the separation between the equipment and receiver.
- Connect the equipment into an outlet on a circuit different from that to which the receiver is connected.
- Consult the dealer or an experienced radio/TV technician for help.

RF EXPOSURE SAFETY INFORMATION:

CAUTION: To comply with the FCC RF exposure requirements, this transmitter (built-in antenna) must be fixed-mounted on permanent structures with a separation distance of at least 8 inches (20cm) from all persons and must not be co-located or operating in conjunction with any other antenna or transmitter.

For CANADA only

Operation is subject to the following two conditions: (1) this device may not cause interference, and (2) this device must accept any interference, including interference that may cause undesired operation of the device.

GENERAL PRECAUTIONS

- Ⓞ If a connection cable is disconnected or has a loose connection during operation, an error may occur. Connect the connectors correctly, and do not touch the connectors during operation.
- Ⓞ For the operation of PC and peripheral devices, follow the instructions provided in the manuals which come with the PC and peripheral devices.
- Ⓞ This device may cause signal interference when used in a domestic setting. When interference occurs, move this unit as far as possible away from the affected device.
- Ⓞ The CD which comes with the AP-12 is for the AP-12 only. Do not use it for any other devices.
- Ⓞ Icom Inc. is not responsible for any interference that arises by incorporating a configuration file for the AP-12 or a firmware update data file, which is available on our home page, into any device other than the AP-12. Moreover, Icom Inc. is not responsible for any interference that arises by modifying or disassembling the AP-12. Furthermore, Icom Inc. is not responsible for any damages, lost profits or third party's claim resulting from any missed communication or telephone call due to the AP-12's fault, error, malfunction, breakage, data loss or any other external factor such as power failure.
- Ⓞ All copyrights associated with this manual and all intellectual property rights associated with the hardware and software of the AP-12 are held by Icom Inc.
- Ⓞ Unauthorised reproduction or transmission of this manual, or any part hereof, is prohibited.
- Ⓞ The content of this manual, the hardware and software associated with the AP-12, and the appearance of the AP-12 are all subject to change without notice.

Notational Conventions

The following notational conventions are used in this manual:

- The names of utilities, menus, windows, tabs, icons, text boxes, and check boxes are enclosed in square brackets ([]).
 - The names of command buttons within dialog boxes are enclosed in less-than and greater-than signs (< >).
- Windows 98 SE represents the Windows 98 Second Edition.
Windows Me represents the Windows Millennium Edition.
- The contents of windows appearing in this manual may vary depending on the operating system installed on your PC.

ACCESSORIES

■ Supplied accessories

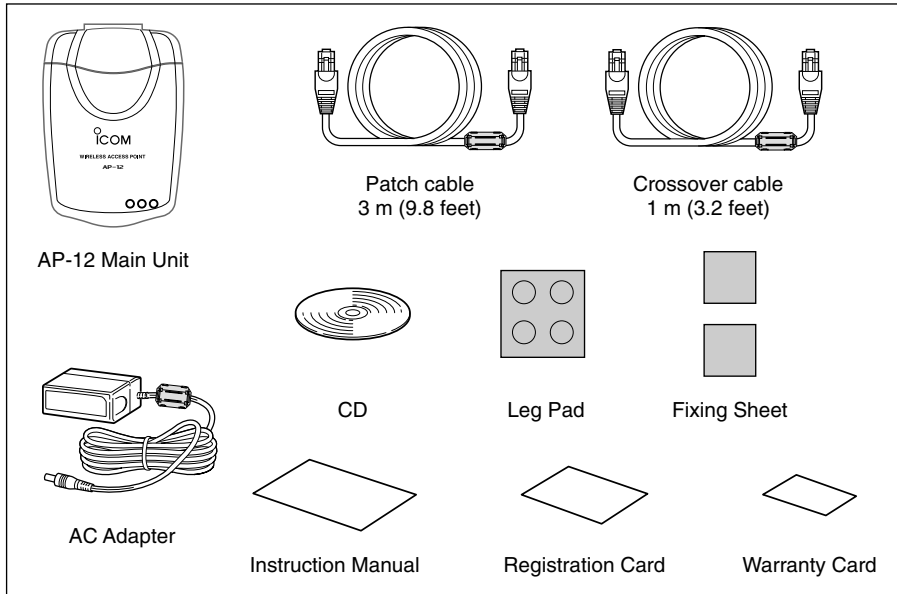

- Leg Pad Attach to the bottom of the AP-12 to secure.
- Fixing sheets Attach to the bottom of the AP-12 to secure.
Remove the protective paper before attaching the sheet.
- Crossover cable..... For connection between the AP-12 and a PC.
- Patch cable..... For network connection between the AP-12 and HUB.
- CD [AP-12 Manager] is included.
- AC Adapter..... The adapter for the AP-12.

TABLE OF CONTENTS

IMPORTANT	ii
INTRODUCTION	iii
ACCESSORIES	vii
TABLE OF CONTENTS	viii
SAFETY PRECAUTIONS	x
Chapter 1	BEFORE INSTALLATION1–8
1-1 Wireless functional modes	2
1-2 Unit description	4
1-3 Accessory attachment	5
1-4 Installation location	7
1-5 About the Ethernet card.....	8
Chapter 2	OBTAINING AN IP ADDRESS FROM THE DHCP SERVER.....9–14
2-1 Connecting to a LAN	10
2-2 Installing [AP-12 Manager]	11
2-3 Starting [AP-12 Manager]	13
Chapter 3	FIXED IP ADDRESS SETTING15–29
3-1 Connecting to the PC	16
3-2 Using [Easy Setting Wizard]	17
3-3 Installing [AP-12 Manager]	25
3-4 Starting [AP-12 Manager]	27
Chapter 4	AP-12 MANAGER31–44
4-1 [AP-12 Manager] screen descriptions	32
4-2 The default settings	43
4-3 Uninstalling [AP-12 Manager].....	44
Chapter 5	SETTING EXAMPLES45–49
5-1 Access point mode	46
5-2 Bridge mode A (Peer-to-Peer)	47
5-3 Bridge mode B (Client Mode).....	48
5-4 Bridge mode C (Multi-site)	49

TABLE OF CONTENTS

Chapter 6	IP CONFIGURATION	51–56
	6-1 For Windows XP	52
	6-3 For Windows 98/98SE/Me	54
	6-2 For Windows 2000	55
Chapter 7	REFERENCES	57–71
	7-1 Troubleshooting	58
	7-2 Connecting the AP-12 and HUB	60
	7-3 Verifying the connection to the AP-12	60
	7-4 Failure in searching for the AP-12.....	61
	7-5 IP address confirmation	64
	7-6 Connection to the router type modem	66
	7-7 Specifications	68
	7-8 Glossary	70

SAFETY PRECAUTIONS

Be sure to read these precautions in order to use the AP-12 safely.

- These precautions are intended to ensure that the access point is operated safely and correctly. Follow these instructions to avoid property damage and prevent personal injury to yourself (user) or others in the vicinity.
- Before reading the rest of this manual, read and understand the precautions listed under “△WARNING” and “△CAUTION”.
- After reading this manual, store it in a convenient place for future review.

■ Wireless Access Point



WARNING

Failure to observe the precautions listed here could result in serious or fatal injury to the user or those near the user.

- **Do not use any AC adapter other than the one provided with this product.**
Otherwise fire, electric shock, or equipment failure may result.
- **Use the specified parts and accessories only.**
Otherwise fire, electric shock, or equipment failure may result.
- **Do not connect the power supply to any terminal other than the DC jack.**
Otherwise fire, electric shock, or equipment failure may result.
- **Do not modify, excessively bend, twist, pull, or heat the connecting cables.**
Otherwise the cables may be damaged and cause a fire, electric shock, or equipment failure.
- **Do not place heavy objects on the connecting cables or allow the cables to be pinched.**
Otherwise the cables may be damaged and cause a fire, electric shock, or equipment failure.
- **Install and use in a location where children cannot reach the power cable and cables.**
Pulled cables could result in electric shock or personal injury.
- **This unit does not require adjustment. Do not disassemble or modify the unit or attempt to repair it yourself.**
Otherwise fire, electric shock, or equipment failure may result.
- **Do not install in a location where the unit can easily become wet (such as adjacent to a humidifier).**
Otherwise fire, electric shock, or equipment failure may result.
- **Do not handle the unit with wet hands.**
Otherwise electric shock may result.
- **Discontinue use immediately and unplug the power cable from the AC receptacle if the unit emits smoke, an abnormal odor, or an abnormal noise or if water enters the unit.**
Otherwise fire, electric shock, or equipment failure may result.
Disconnect the plug of the AC adapter and all other cables from the unit.
Confirm that the smoke, odor, or noise has stopped and contact your dealer.

SAFETY PRECAUTIONS



CAUTION

Failure to observe the precautions listed here could result in personal injury or property damage.

- **Do not install the unit outdoors.**
Otherwise equipment failure may result.
- **Do not place on a slanted or unstable surface.**
Otherwise the unit may tilt over or fall, resulting in personal injury or equipment failure.
- **Avoid installing in humid, dusty, or poorly ventilated locations.**
Otherwise equipment failure may result.
- **Do not use in locations exposed to direct sunlight, close to heating or cooling ducts, or other areas subject to severe fluctuations in temperature.**
Otherwise the unit may become deformed or discolored. Also, fire or equipment failure may result.
- **Be sure to connect the cables correctly as explained in this manual. Do not use any other connection arrangement.**
Otherwise equipment failure may result.
- **Avoid locations exposed to strong magnetic fields or static electricity and locations exposed to temperatures or humidity levels that exceed the specifications listed in the manual.**
Otherwise equipment failure may result.
- **Do not use close to radios or television sets.**
Otherwise signal interference may occur.
- **Do not drop or the unit or subject it to strong physical shock.**
Otherwise personal injury or equipment failure may result.
- **Do not stand, sit, or place heavy objects on the unit. Do not pinch the unit.**
Otherwise the unit may be damaged.
- **When thunder and/or lightning occur nearby, disconnect the AC adapter from the wall socket and do not use the unit. Also, discontinue such work as connecting cables, disconnecting cables, installation, or maintenance.**
Otherwise fire or electric shock may result.
- **Do not use in locations where condensation is likely to occur. Avoid hastily moving the unit to a location where the humidity level is very different because condensation may occur.**
Otherwise the unit may become deformed or discolored. Also, fire or equipment failure may result.
If condensation occurs, dry the unit or allow the unit to remain in the same environment until it is completely dry before using it again.
- **Disconnect the AC adapter from the unit when the unit will not be used for a long time.**
Otherwise the unit may become hot and fire or equipment failure may result.
- **Do not clean with paint thinner or benzene.**
Otherwise the case material may degrade or the coating may peel. Clean with a soft cloth. When particularly dirty, dampen the cloth slightly with a neutral cleaning agent that has been diluted with water.

SAFETY PRECAUTIONS

■ AC adapter



WARNING

Failure to observe the precautions listed here could result in serious or fatal injury to the user or those near the user.

- **Do not use with an AC supply voltage other than 230 V.**
Otherwise fire, electric shock, or equipment failure may result.
- **Do not use with any device other than the AP-12.**
Otherwise fire, electric shock, or equipment failure may result.
- **Do not modify, excessively bend, twist, pull, or heat the AC power cable.**
Otherwise the cable may be damaged and cause a fire, electric shock, or equipment failure.
- **Do not place heavy objects on top of the DC output cable or allow the cable to be pinched.**
Otherwise the cable may be damaged and cause a fire, electric shock, or equipment failure.
- **Hold the adapter body when plugging in and unplugging the AC adapter. Do not yank the cable.**
Otherwise fire, electric shock, or equipment failure may result.
- **Do not handle the AC adapter plug or other devices with wet hands.**
Otherwise electric shock may result.
- **Do not use the AC adapter if the DC output cable is damaged or the plug does not fit securely into the receptacle.**
Otherwise fire, electric shock, equipment failure, or data loss may result. Consult with your dealer or the service staff at one of our sales offices regarding how to handle the problem or obtain a new AC adapter.

General Precautions

- The unit may malfunction if the connecting cables become disconnected or the connection is unstable while the unit is in operation. Be sure all connectors are securely fastened and do not touch them while the unit is in operation.
- Observe the instructions provided in the manuals included with the PC and other peripheral devices.
- This device may cause signal interference when used in a domestic setting. When interference occurs, move this unit as far as possible away from the affected device.
- The disks entitled "Utility Software" (utility for updating the firmware) is specifically intended for this unit. Do not use the disks with any other device.
- ICOM Inc. assumes no responsibility whatsoever for any trouble resulting from using the data files originally provided with this unit or the firmware update data files provided on our website in a device other than this unit, or modifying or disassembling this unit. Nor does ICOM Inc. assume any responsibility whatsoever for any damages or lost profits resulting from opportunities for voice or signal communications being lost because of the failure, malfunction, poor condition, damage, or data loss of this unit or because of such external causes as power failure. ICOM also dismisses all responsibility for demands made by a third party.
- All copyrights associated with this manual and all intellectual property rights associated with the hardware and software of this product are held by ICOM Inc.
- Unauthorised reproduction or transmission of this manual, or any part hereof, is prohibited.
- The content of this manual, the hardware and software associated with this product, and the appearance of this product are all subject to change without notice.



This chapter describes what you should consider and prepare before installing the AP-12.

1-1 Wireless functional modes	2
■ Access point mode	2
■ Bridge mode A (Peer-to-Peer)	2
■ Bridge mode B (Client Mode)	3
■ Bridge mode C (Multi-site)	3
■ About a MAC address	3
1-2 Unit description	4
1-3 Accessory attachment	5
■ Leg pads/fixing sheet attachment.....	5
■ To avoid falling.....	5
■ To avoid interference	6
1-4 Installation location	7
■ Examples of recommended installation	7
■ Examples of installation not recommended	7
■ Installation precautions	7
1-5 About the Ethernet card	8
■ Desktop PC	8
■ Notebook PC	8

1-1 Wireless functional modes

The AP-12 has 4 wireless functional modes.

A functional mode can be selected with [AP-12 Manager].

- The AP-12 obtains an IP address from the DHCP server automatically (default).
- Bridge mode B does not support a DHCP client function.
- Connect the AP-12 to the PC directly (p. 16), then set the IP address when you use the fixed IP address in the existing wired LAN.

■ Access point mode (default)

The AP-12 in access point mode connects the wireless LAN clients to the other wireless LAN clients or wired LAN.

To avoid communication speed slow down, it is recommended to use up to 10 AP-12's only during heavy traffic.

By connecting two or more AP-12's to the wired LAN, roaming is possible. The roaming function switches to the most suitable access point automatically when the wireless LAN client moves.

Set the channels at least four channels apart to avoid interference.

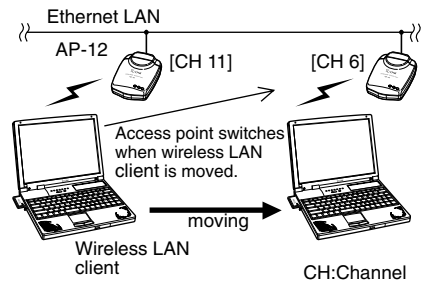
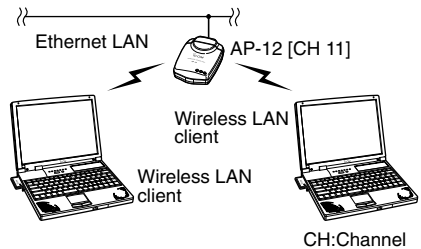

■ Bridge mode A (Peer-to-Peer)

Connects two wired LAN via the AP-12.

Only AP-12's whose MAC address is registered to one another, can be accessed.

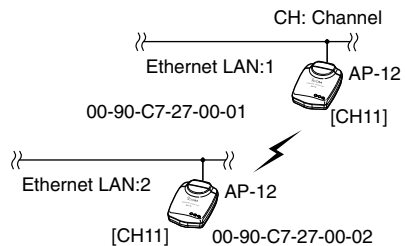

■ **Bridge mode B (Client Mode)**

Connects wireless LAN terminal or the AP-12 (2) connected LAN system via the AP-12 (1) in access point mode.

- Only the AP-12 works as the access point.
- Register the desired AP-12's MAC address, prior to communication, with AP-12 (2) when two or more AP-12's operating in access point mode are available.

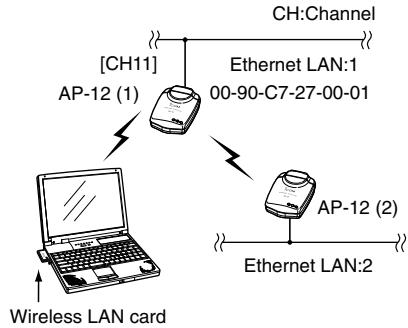

■ **Bridge mode C (Multi-site)**

Connects two or more wired LAN via the AP-12.

- It is not necessary to register the MAC address and communicate with other AP-12s easily.
- To avoid communication speed slow down, it is recommended to use up to 10 AP-12's only during heavy traffic.

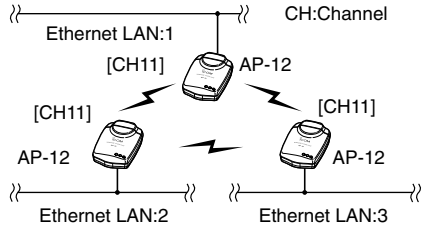

■ **About a MAC address**

A MAC address is described on the serial number seal. (See the figure at right)

In bridge mode A, you need to register your MAC address to the wireless devices with which you communicate. In bridge mode B, register the desired wireless LAN device's MAC address prior to communication with your AP-12.

The AP-12's MAC address can be checked with [AP-12 Manager] also.

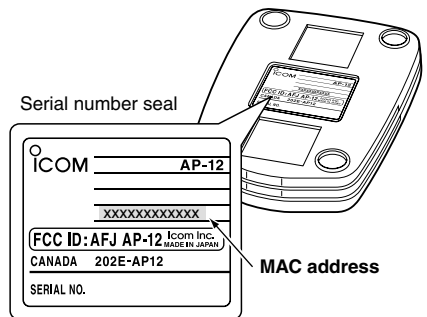

1 BEFORE INSTALLATION

1-2 Unit description

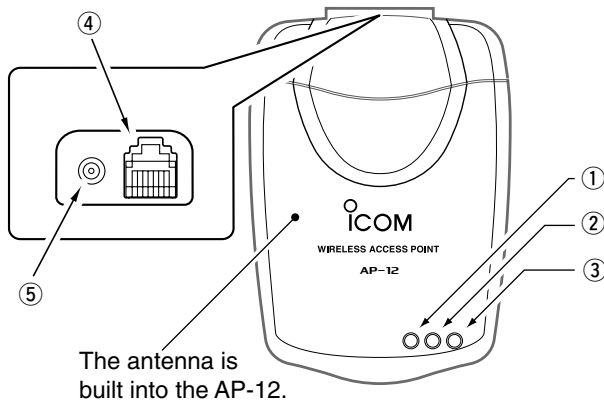

- ① Power indicator
 - Lights when the power is ON.
- ② Wired LAN indicator
 - Lights when the LAN (Ethernet) connection is correct.
 - Flashes when the AP-12 is communicating with the LAN.
 - It does not light when the AP-12 does not recognize the Ethernet port connection.
 - Make sure the LAN cable is connected to the Ethernet port.
- ③ Wireless LAN indicator
 - Flashes when the power is ON.
 - Flashes high speed while communicating data.
- ④ Ethernet ports
 - This is an RJ-45 type Ethernet port.
 - Connect to a HUB using the supplied patch cable.
 - Connect to a PC using the supplied crossover cable.
- ⑤ DC jack
 - Connect the supplied AC adapter.

1-3 Accessory attachment

■ Leg pads/fixing sheet attachment

Use the leg pads on the bottom of the AP-12 as below to place it on a flat surface

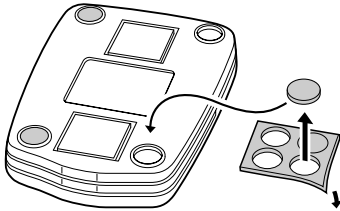

Use the fixing sheets to secure the AP-12 on a shelf.

Remove the protective paper before attaching the sheet.

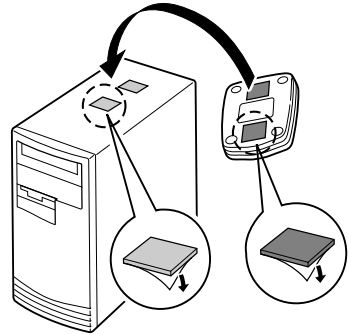

■ To avoid falling

When mounting the AP-12 high on a shelf or the like, secure it using a cable fastener or tie to prevent the AP-12 from accidental falling.

NOTE: Do not tie and fix the DC power cable and Ethernet cable with a metal binder, such as a wire. The cable may be damaged and a short circuit may occur.

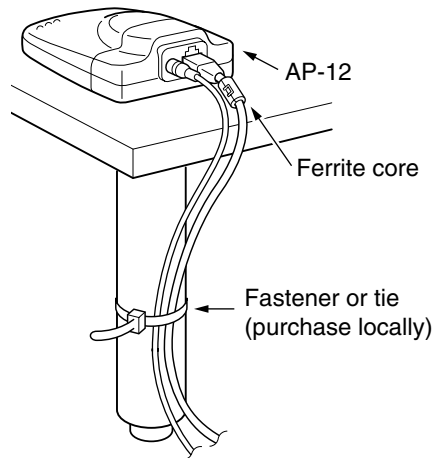

1 BEFORE INSTALLATION

1-3 Accessory attachment (continued)

■ To avoid interference

Do not detach the ferrite core from both the AC adapter and the Ethernet cable. Otherwise interference may occur when you use these items without the ferrite core.

◇ AC adapter

AC adapter (supplied)

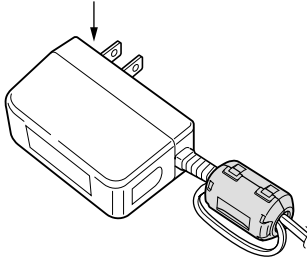

◇ Ethernet cable

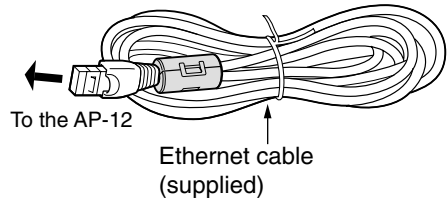

1-4 Installation location

The transmission range and speed may change according to the installation location. Installing the AP-12 in wide, open air with clear line of sight (example; a high place) is recommended.

Approximate operating range at 11 Mbps speed is 30 m (98 ft) for indoor operation.

■ Examples of recommended installation

On a desktop PC

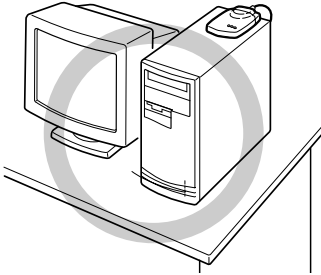

On a shelf

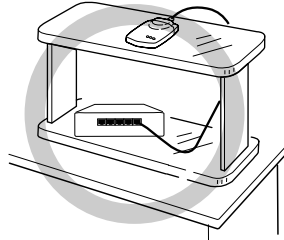

■ Examples of installation not recommended.

(Transmission range and speed may decrease)

Do not install behind objects

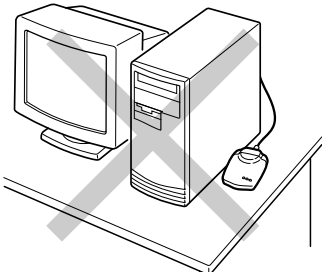

Do not install with the unit dangling down

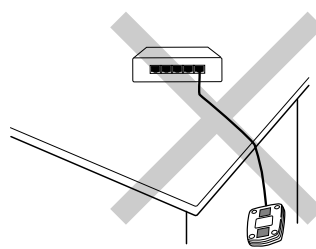

■ Installation precautions

Select a location as high as possible to keep a clear line of sight.

Install on a stable, flat surface without a slant, and no vibrations as the unit may fall.

Please be reminded of the following points for installation.

- NEVER put anything on the AP-12, nor stack the AP-12s on top of each other.
- Floors generally have steel girders and are installed with metal fire protection material. Consequently, communication between different floors is often not possible.
- The transmission range is the widest in an open space. However, the signal may be reflected from large metal walls in such a location as a warehouse.
- Radio signals will pass through walls and glass but not through metal. Concrete walls may be reinforced with steel or other metal material that will block the signal.

1-5 About the Ethernet card

An Ethernet port is necessary in your PC for set up.

Check that an Ethernet port is available with your PC before setting up.

- If no Ethernet port is available, purchase a suitable Ethernet card separately according to the slot type.

■ Desktop PC

Install the Ethernet card into an expansion slot.

Several types of expansion slots are available, such as PCI, ISA, etc.

Therefore, check the vacant expansion slot type before purchasing the Ethernet card.

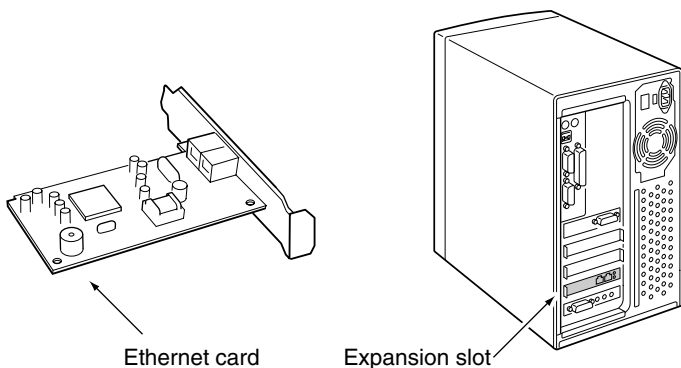

■ Notebook PC

Install the Ethernet PC card into the PC card slot.

Check the Ethernet PC card type in the specifications of the PC card slot before installing.

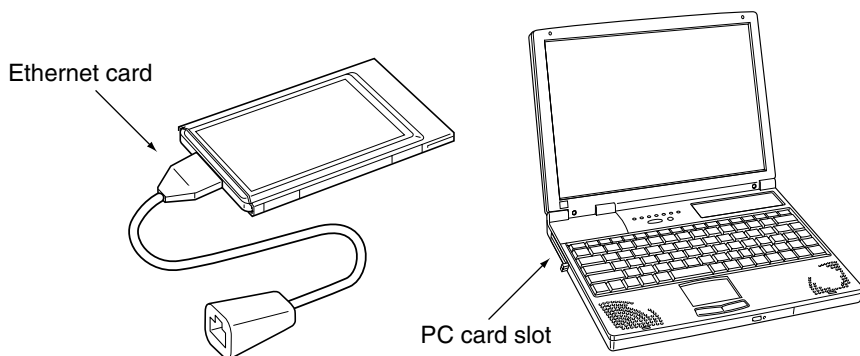

OBTAINING AN IP ADDRESS FROM THE DHCP SERVER

Chapter 2

This chapter describes setting instructions when setting up the AP-12's IP address via the DHCP server (default setting in "IP Configuration").

See Chapter 3 when using the fixed IP address for the AP-12 or return to the default setting.

2-1 Connecting to a LAN	10
2-2 Installing [AP-12 Manager]	11
2-3 Starting [AP-12 Manager]	13
■ [AP-12 Manager] Settings Screen	14

2 OBTAINING AN IP ADDRESS FROM THE DHCP SERVER

2-1 Connecting to a LAN

This section enables a DHCP server to assign an IP address automatically.

[Procedure]

- ① Connect the AP-12 and LAN with the supplied patch cable.
- ② Connect the AC adapter to the AC outlet to turn the AP-12 power ON.
 - POWER indicator and wired LAN indicator on the top panel lights.
 - Wireless LAN transmission indicator on the top panel flashes.

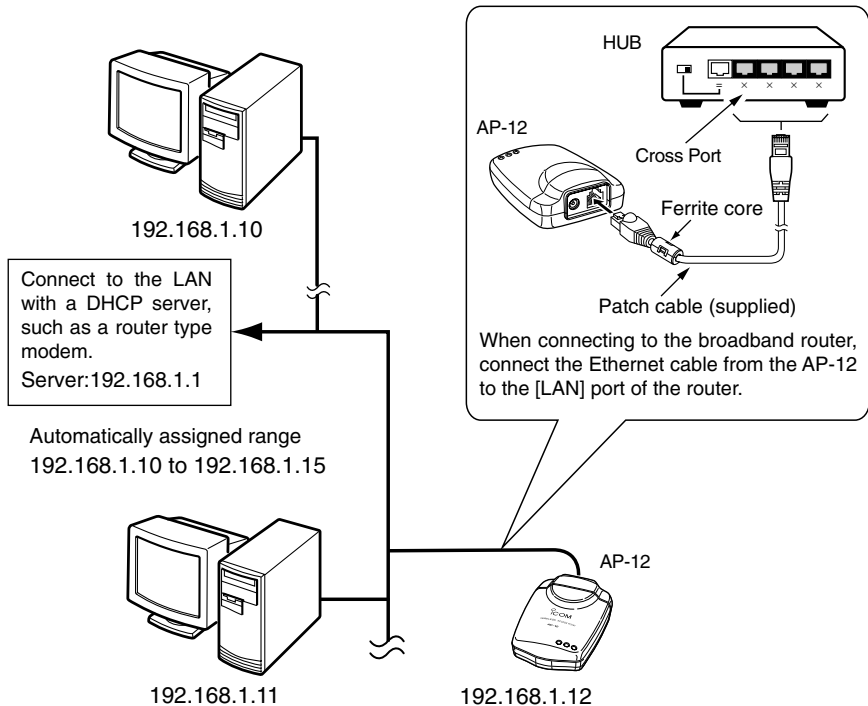

◆ About DHCP server detection

The AP-12 searches the DHCP server automatically to connect with a wired LAN in which the DHCP server exists in. When no DHCP server is found within 30 sec. (approx.) from power ON, the default IP address is used for the AP-12.

The default IP address is "192.168.0.1". However, when a DHCP server is found in the network, the AP-12 use the IP address obtained from the server.

Once the AP-12 power is turned OFF, then ON again, the AP-12 starts searching for the DHCP server for 30 sec. (approx.) again.

2-2 Installing [AP-12 Manager]

When installing into a Windows XP or Windows 2000 environment, log on as the **administrator**.

- ① Quit all applications when Windows is running.
- ② Insert the CD into the CD-ROM drive.

The Auto Run function will be activated and the main menu will appear on the screen as at right.

▨ If the main menu does not appear, double-click the “AutoRun.exe” contained in the CD.

- ③ Click [Install Utility].
- ④ Click <Next>.

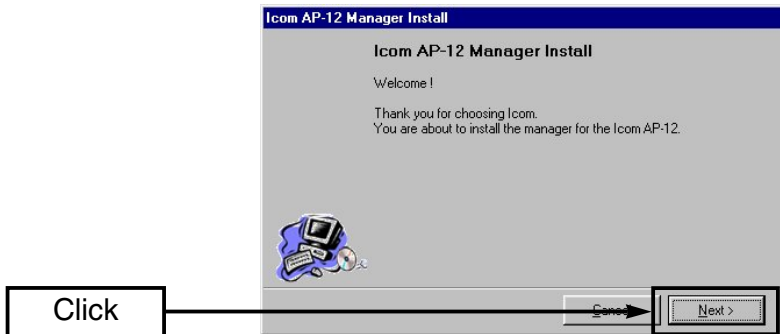
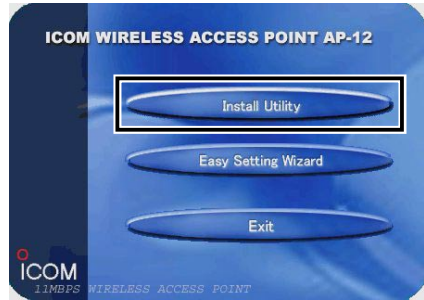

- ⑤ Verify the directory in which you want to install to, then click <Next>.
 - Click <...> and select the desired directory, if necessary.

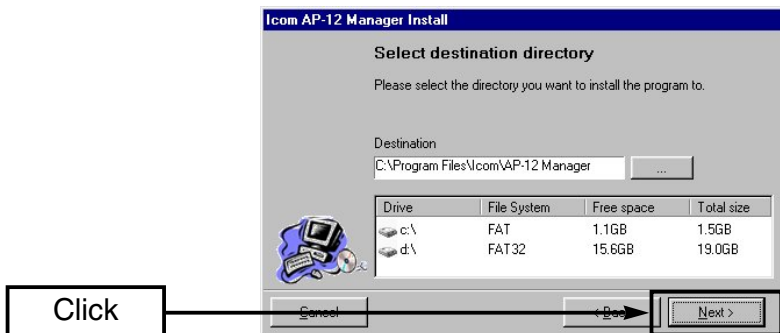

2 OBTAINING AN IP ADDRESS FROM THE DHCP SERVER

2-2 Installing [AP-12 Manager] (continued)

- ⑥ When the dialog “Create new directory?” appears, click <OK>.
- ⑦ Click <Install>.



- ⑧ Click <Finish>.
- The installation is now completed.

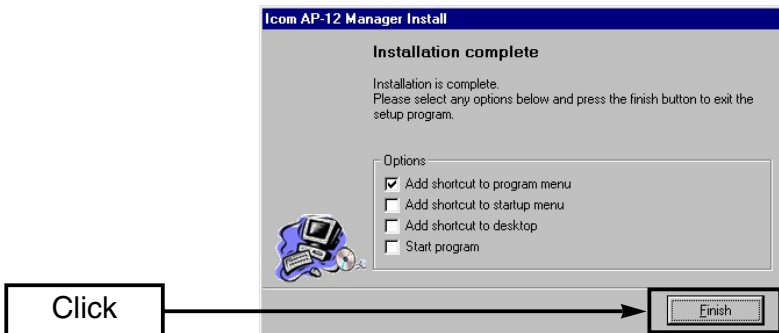

- ⑨ Click <Exit> to close the main menu.

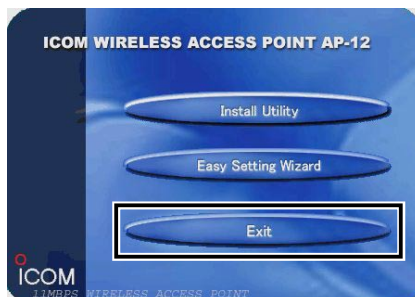

2-3 Starting [AP-12 Manager]

This section describes about the verification of the IP address obtained, using the [AP-12 Manager].

- Supposing that the connection between the LAN and AP-12 has already been done in this section.
- Quit [Easy Setting Wizard] when it is running.

[Procedure]

- ① Click <Start> and select [AP-12 Manager] from the [Program menu].
- ② Click <Search>, then verify the IP address obtained.
 - When no IP address is displayed, click <Search> again.

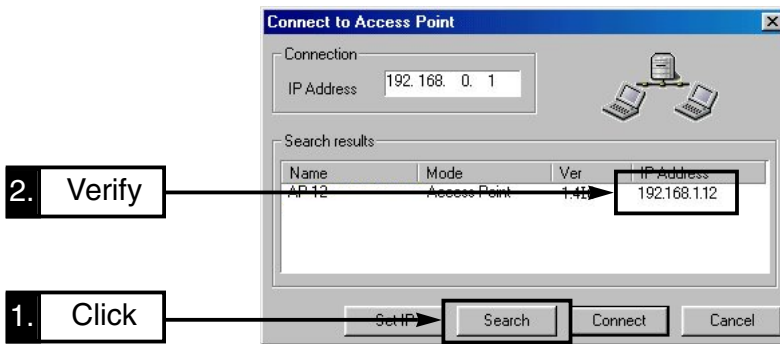

- ③ Click the desired access point name and then click <Connect>.
 - [AP-12 Manager] Setting screen (p. 14) appears on the screen.

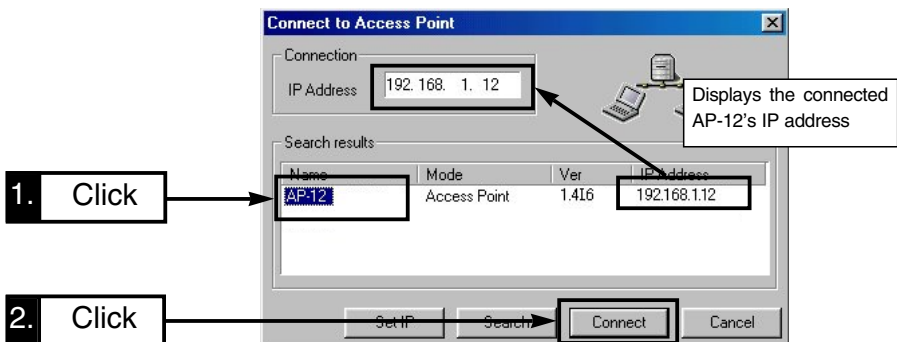

About AP-12 icon:

An icon is displayed on the task bar while the [AP-12 Manager] is activated.



Right-click the icon and select "Connect to access point" from the menu to open the [AP-12 Manager] setting screen.

2 OBTAINING AN IP ADDRESS FROM THE DHCP SERVER

2-3 Starting [AP-12 Manager] (continued)

■ [AP-12 Manager] Setting Screen

After installing [AP-12 Manager], the following screen appears first.

① to ④ are common buttons in the [AP-12 Manager] screen.

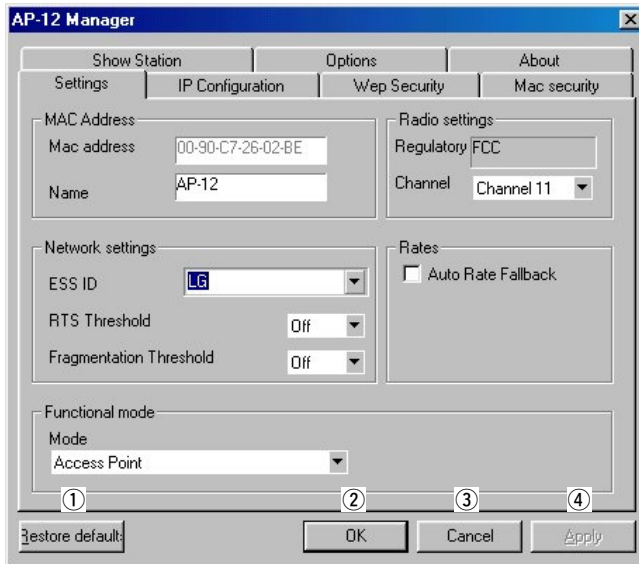

① <Restore default>

Restores all the contents of the screen to the default settings.

The AP-12 searches the DHCP server and sets an IP address obtained from the server.

See Chapter 3 to restore completely.

② <OK>

Registers the value or condition of all contents in the screen to the AP-12 and closes the screen.

③ <Cancel>

Cancels the value or condition of all contents registration in the screen and closes the screen.

④ <Apply>

Registers the value or condition of all contents in the screen only. The screen is kept open.

To exit [AP-12 Manager]

Move the cursor on the icon in the task bar then right-click.

Select "Exit" in the menu that appears.



FIXED IP ADDRESS SETTING

Chapter 3

This chapter describes how to set the fixed IP address to the AP-12 or restore to the default setting.

3-1 Connecting to the PC	16
3-2 Using [Easy Setting Wizard]	17
3-3 Installing [AP-12 Manager]	25
3-4 Starting [AP-12 Manager]	27
■ [AP-12 Manager] Settings screen	29

3 FIXED IP ADDRESS SETTING

3-1 Connecting to the PC

[Procedure]

- ① Connect the AP-12 and the PC with the supplied crossover cable.
 - Use the supplied patch cable (3 m: 9.8 ft) when connecting the AP-12 and the PC via a HUB.
- ▨ **NOTE: DISCONNECT THE PC FROM THE EXISTING LAN.**
 - ▨ When the PC is connected to the existing LAN, the AP-12 searches the DHCP server and uses the IP address obtained from the server according to the default setting.
- ② Connect the supplied AC adapter to the AP-12 and an AC outlet.
 - The Power indicator lights.
 - The wireless LAN indicator flashes.
- ③ Start up the PC.
 - The wired LAN indicator on the top panel lights.
Check the Ethernet cable if the wired LAN indicator does not light.

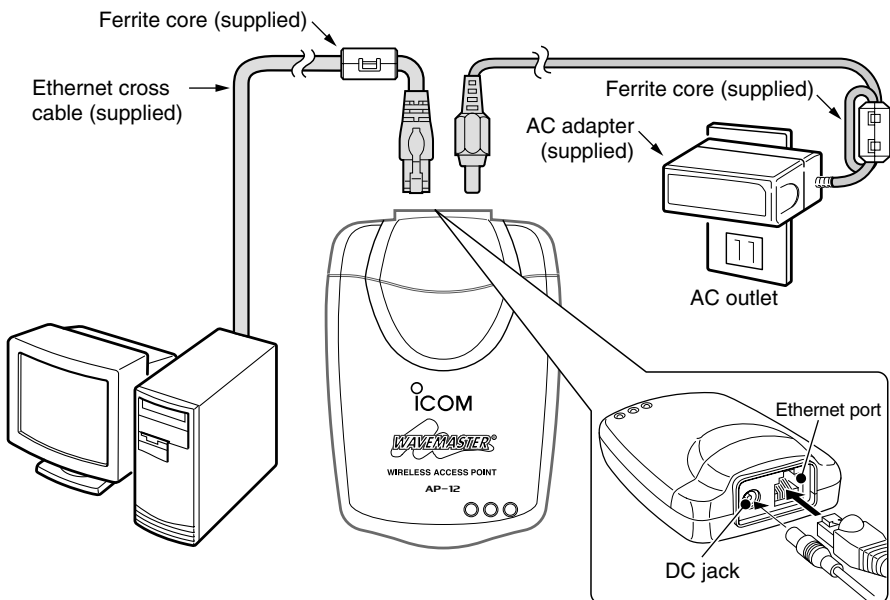

3-2 Using [Easy Setting Wizard]

Changing the PC's IP address is necessary using [Easy Setting Wizard] when setting up the AP-12. [Easy Setting Wizard] is contained in the utility CD and it allows easy setting for changing the IP address.

[Procedure]

- ① Quit all applications when Windows is running.
- ② Insert the CD into the CD-ROM drive.
The Auto Run function will be activated and the main menu will appear on the screen as at right.
 // If the main menu does not appear,
 // double-click the "AutoRun.exe" con-
 // tained in the CD.
- ③ Click [Easy Setting Wizard].
- ④ Click <Next>.

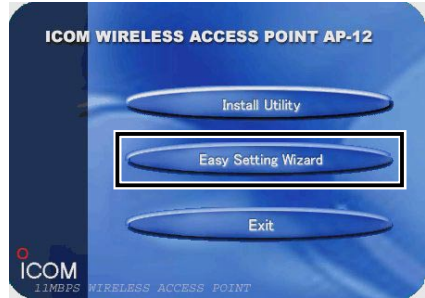

◆ About [Easy Setting Wizard]

[Easy Setting Wizard] enables the PC to access the AP-12 temporarily without changing the PC's IP address.

The wizard searches for both the AP-12 and PC's address settings automatically.

When the PC is unable to access to the AP-12, the wizard assigns a tentative IP address to the PC.

The original IP address remains, therefore, the PC can be used in the previous setting condition after the AP-12 set-up.

- [Easy Setting Wizard] can be started up from the supplied CD drive only. (Unable to install.)
- When a new network is built, the IP address of the PC using the AP-12, must be changed.

Refer to Chapter 6 (p. 51) for details.

3 FIXED IP ADDRESS SETTING

3-2 Using [Easy Setting Wizard] (continued)

- ⑤ Click <Next> to start searching the AP-12.

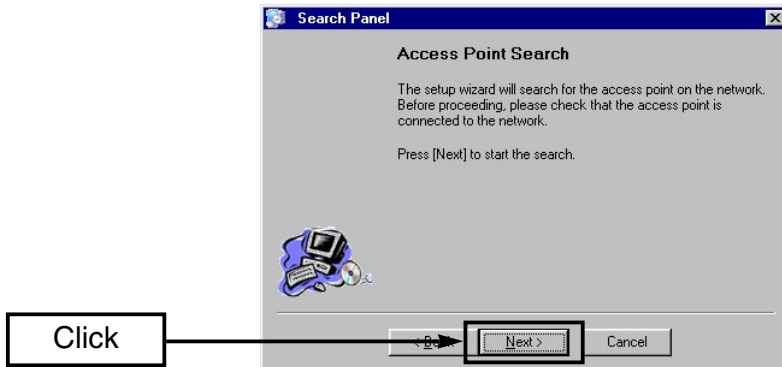

- ⑥ Click the desired access point name you want to set up, then click <Next>.
- The default IP address is [192.168.0.1]. However, once the AP-12 has been connected to a LAN with a DHCP server, a different IP address may be obtained.

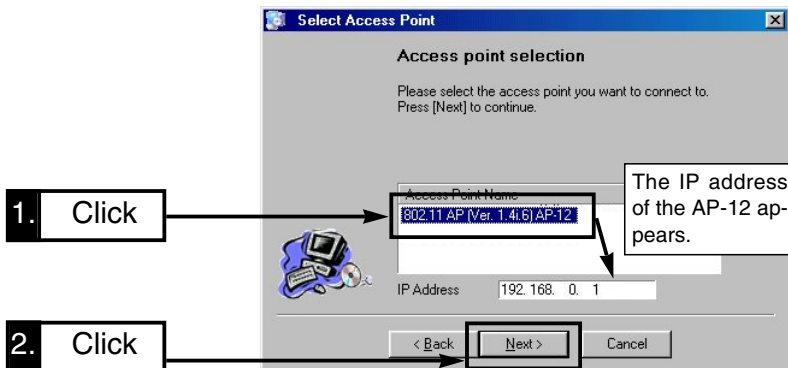

When no access point is found:

When the error dialog “Cannot connect to the access point” appears after approx. 30 sec.

➔ Check the connection between the AP-12 and the PC.
(p. 16)

➔ The network part may be different between the AP-12 and the PC in case the access point has been used with the fixed IP address. Refer the Chapter 7-4 (p. 61) in such a case.



⑦ When the PC cannot access the AP-12 due to a network address difference between them, the following screen appears.

Enter the desired unique host address for the PC, then click <Next>.

- When the PC can access the AP-12, the screen described in step ⑫ appears.
- The default IP address of the AP-12 is “192.168.0.1”.
- Enter a value other than “1” in the address box.

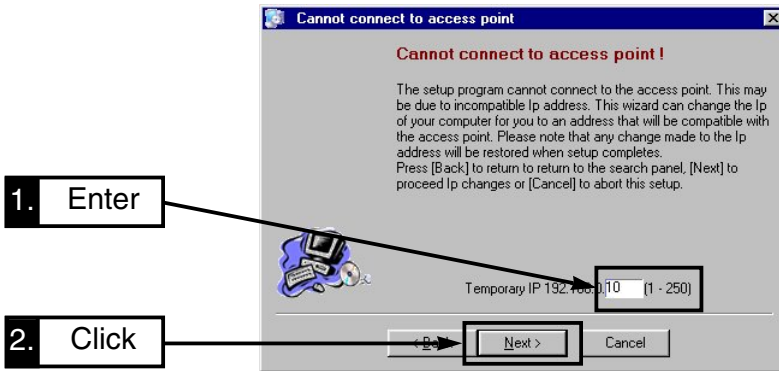

◆ About IP Address

The IP addresses consist of two elements, network part and host address. For example, “192.168.0.1” (default IP address of the AP-12; class C) has the network part “192.168.0” and host address “1”. Network devices, such as the PC, with the same network part are recognized in the same network, and the each device is distinguished by the host address. Pay attention to the notes at right when obtaining IP addresses.

- Assign the same network to the all network devices in the same group.
- Assign an unique host address for each device in the same group.
- NEVER assign a “network address” (host address is 0 or starting from 0.)
- NEVER assign a “broadcast address” (host address is 255).

3 FIXED IP ADDRESS SETTING

3-2 Using [Easy Setting Wizard] (continued)

- ⑧ Select [Restart Windows now] and click <Finish>.
- The PC will restart.

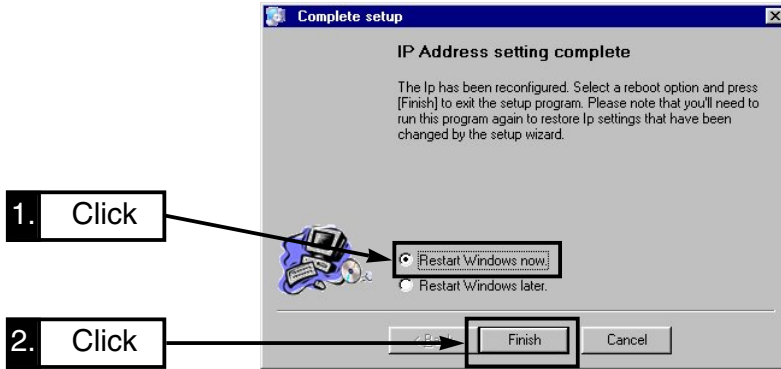

- ⑨ [Easy Setting Wizard] will restart automatically.
- Click <Next>.



⑩ Click <Next>.

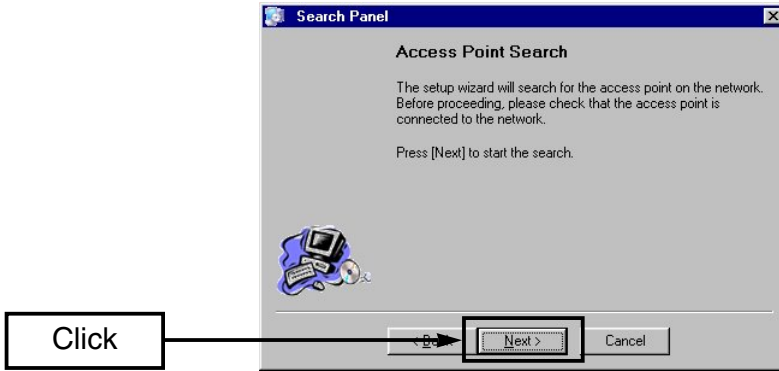

⑪ Click the access point, selected in step ⑦, and click <Next>.

- The default IP address of the AP-12 is "192.168.0.1".

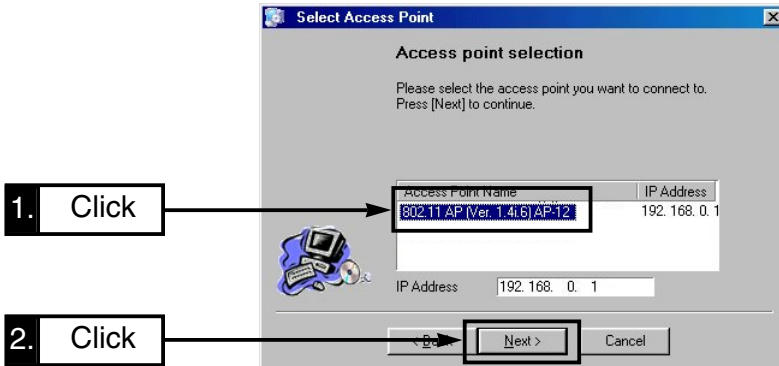

3 FIXED IP ADDRESS SETTING

3-2 Using [Easy Setting Wizard] (continued)

⑫ Select [Use a fixed IP address] and click <Next>.

- The screen in step ⑭ appears when [Use dynamic IP address alloc] is selected.

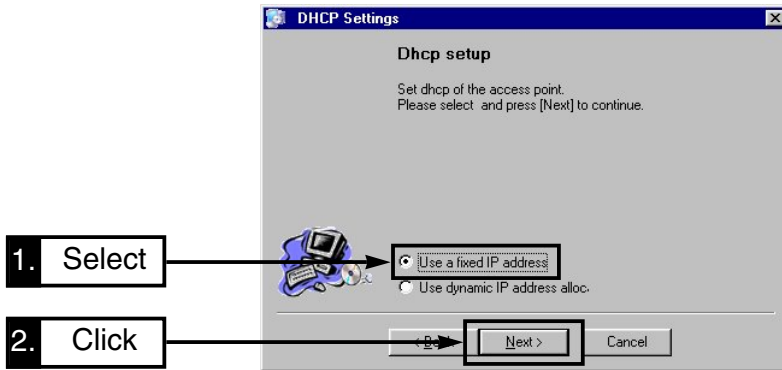

⑬ Enter the IP address and subnet mask for the AP-12.

- The network part must be the same as the PC IP address, and the host address must be different from the other devices.
- Click <Next>.

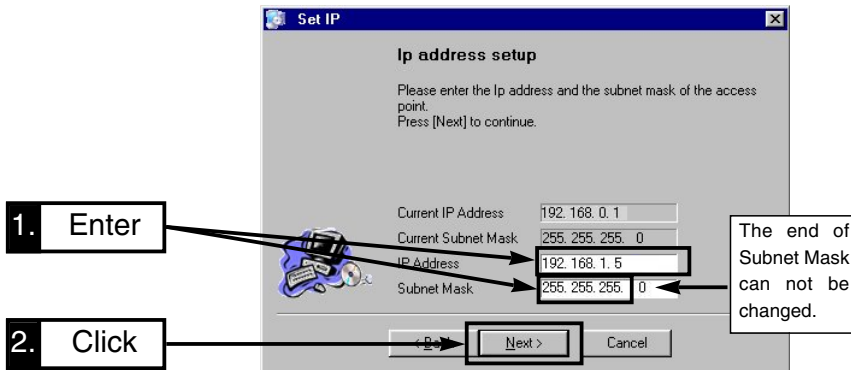

⑭ Set the ESS ID, then click <Next>.

The default ID (LG) is used in this example.

- The AP-12 can communicate with the unit in which the same ESS ID as the AP-12 and wireless LAN card is set.
- Click <Next> without changing the ESS ID, if desired.

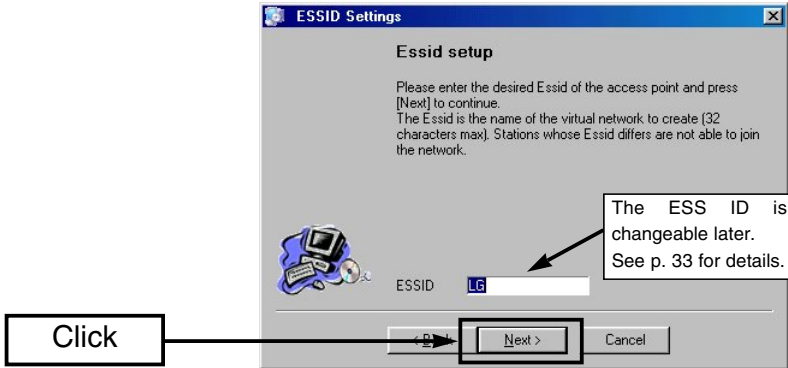

⑮ Set the channel number, then click <Next>.

The default channel (11) is used in this example.

- The same channel should be selected for the Bridge A or C operation.
- Click <Next> without changing the channel, if desired.

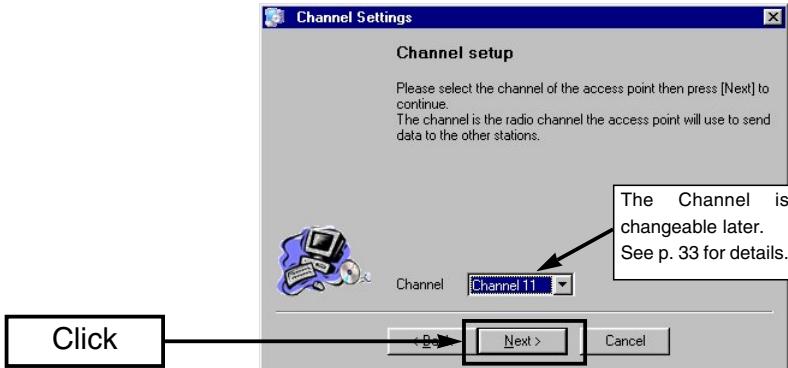

3 FIXED IP ADDRESS SETTING

3-2 Using [Easy Setting Wizard] (continued)

⑩ Click <Next> to apply the settings to the AP-12.

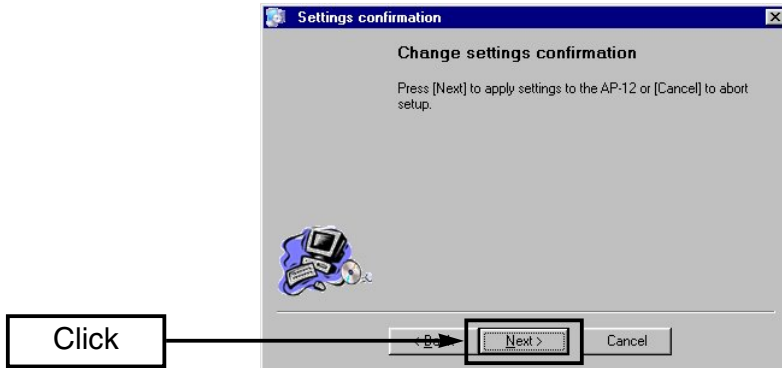

⑪ Click <Finish>.

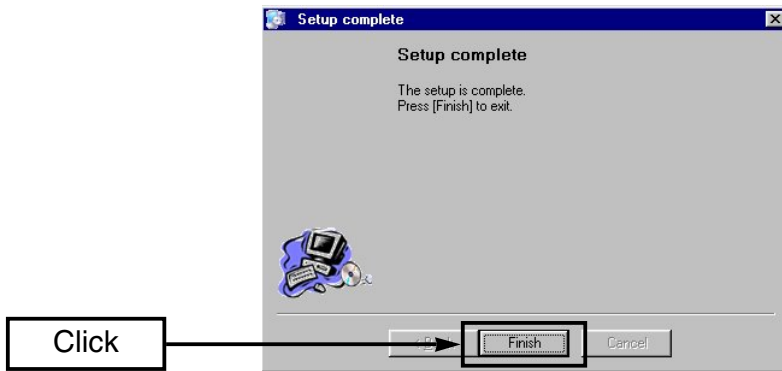

⑫ When the dialog “Reboot now?” appears on the screen, click <Yes>.

- When the PC can be connected to the AP-12 in step ⑦, this dialog does not appear on the screen.



⑬ The PC reboots.

- After rebooting, the original IP address remains when a tentative IP address is assigned in step ⑦.

3-3 Installing [AP-12 Manager]

This section describes the settings utility, [AP-12 Manager], installation.

[Procedure]

When installing into Windows XP or Windows 2000 environment, log on as the **administrator**.

- ① Quit all applications when Windows is running.
- ② Insert the CD into the CD-ROM drive.
The Auto Run function will be activated and the main menu will appear on the screen as at right.
 ▮ If the main menu does not appear, double-click the “AutoRun.exe” contained in the CD.
- ③ Click [Install Utility].
- ④ Click <Next>.

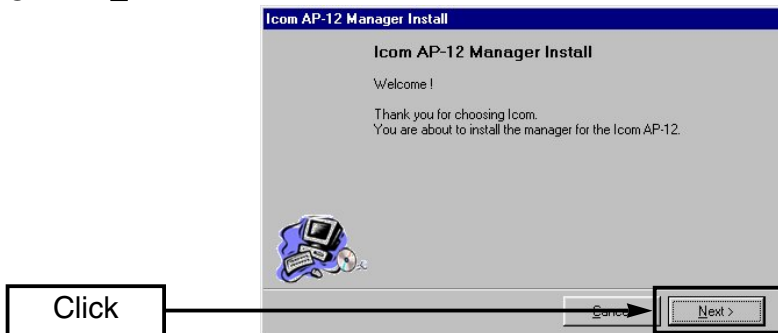
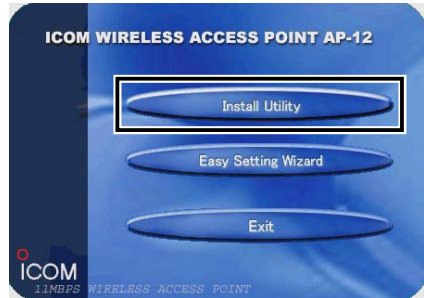

- ⑤ Verify the directory in which you want to install to, then click <Next>.
 - Click <...> and select the desired directory, if necessary.

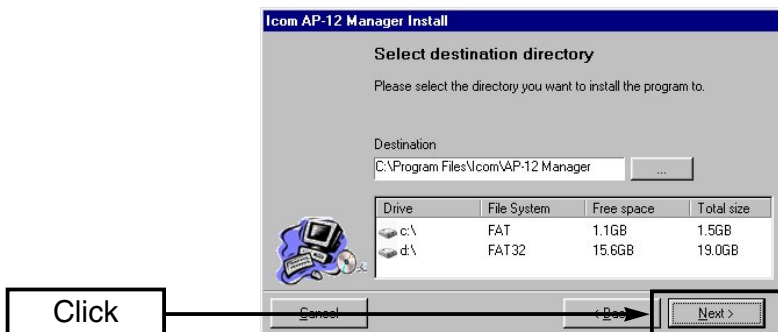

3 FIXED IP ADDRESS SETTING

3-3 Installing [AP-12 Manager] (continued)

- ⑥ When the dialog “Create New Directory” appears, click <OK>.
- ⑦ Click <Install>.



- ⑧ Click <Finish>.
- The installation is now completed.

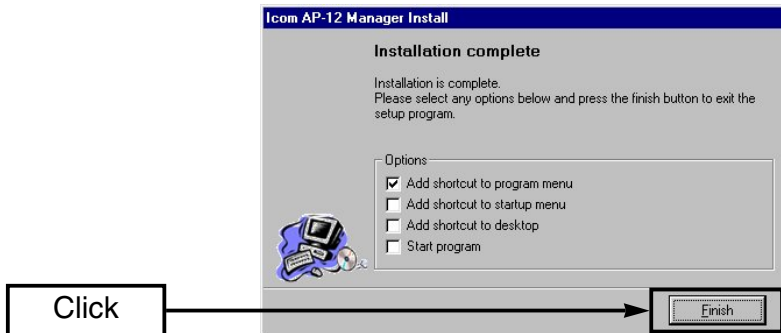

- ⑨ Click <Exit> to close the menu.
- ⑩ Start [AP-12 Manager].
 - See next page if the AP-12 is connected to the PC.
 - See Chapter 2-3 (p. 13) if you reconnect the AP-12 to a LAN network via a HUB.

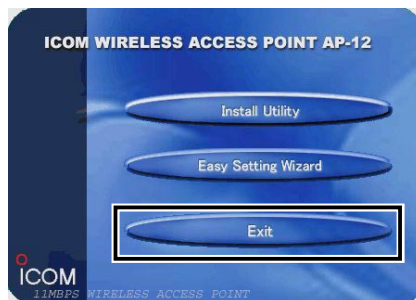

3-4 Starting [AP-12 Manager]

This section describes how to start up [AP-12 Manager].

- Quit [Easy Setting Wizard] when it is running.

[Procedure]

Be sure to install [AP-12 Manager] to the PC.

- ① Click <Start> and select [AP-12 Manager] from the [Program menu], then click <Search>.
 - When no IP address is displayed, click <Search> again.

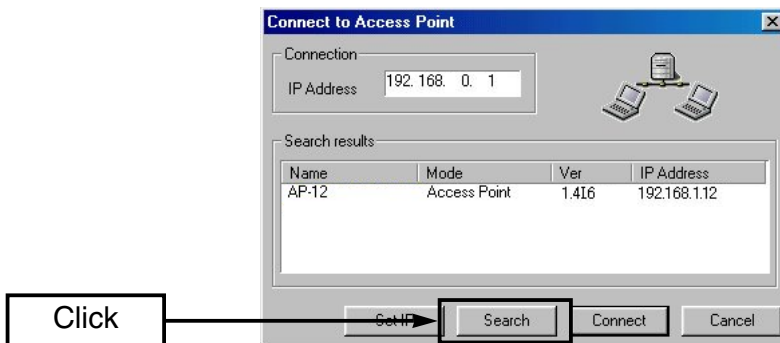

- ② Click the access point name and then click <Connect>.
 - [The AP-12 Manager] Settings screen (p. 29) appears on the screen.

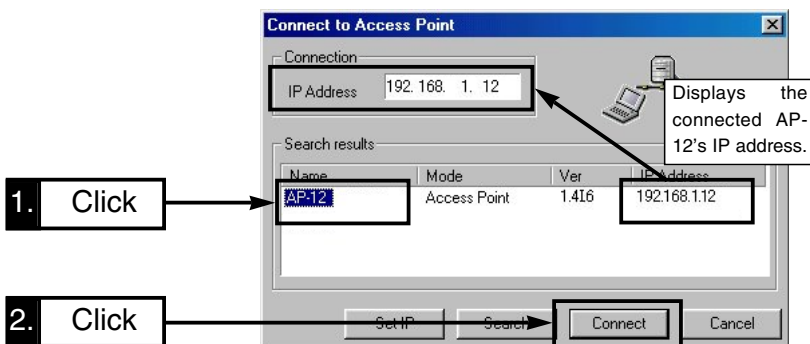

About AP-12 icon:

An icon is displayed on the task bar while [AP-12 Manager] is activated.

Right-click the icon and select "Connect to access point" from the menu to open [AP-12 Manager] Settings screen.



3 FIXED IP ADDRESS SETTING

3-4 Starting [AP-12 Manager] (continued)

- ③ When the error dialog “Cannot connect to the access point” appears on the screen, each AP-12 and the PC’s network IP address may be different. In such a case, click <OK> and close the dialog. Then, exit [AP-12 Manager].



To exit the AP-12 Manager:

Move the cursor on the icon in the task bar, then right-click. Then select “Exit” in the menu that appears.



- ④ Follow the steps ① to ⑧ in Chapter 3-2 (p. 17) to set up the PC again.
- ⑤ The following screen appears after rebooting.
Click <Cancel>.



- ⑥ Follow the steps ① and ② in Chapter 3-4 (p. 27) to re-starting [AP-12 Manager] again.
- [AP-12 Manager] Settings screen as in page 29 is displayed when the setting is successful.

■ [AP-12 Manager] Settings screen

After installing [AP-12 Manager], the following screen appears first.

① to ④ are common buttons in the [AP-12 Manager] screen.

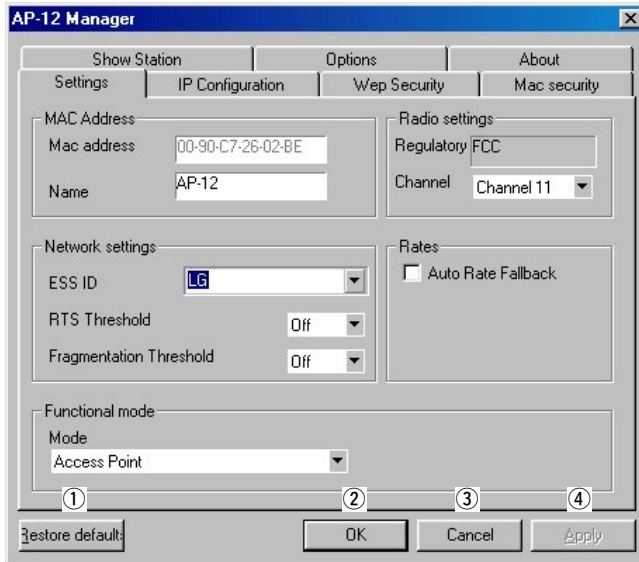

① <Restore default>

Restores all the contents of the screen to the default settings.

The AP-12 searches the DHCP server and sets the IP address obtained from the server.

② <OK>

Registers the value or condition of all contents in the screen to the AP-12 and closes the screen.

③ <Cancel>

Cancels the value or condition of all contents registration in the screen and closes the screen.

④ <Apply>

Registers the value or condition of all contents in the screen only. The screen is kept open.



This chapter describes for the details of [AP-12 Manager].

See Chapter 1 (p. 1) or 2 (p. 9) for installing and starting details of [AP-12 Manager], according to the operating mode.

4-1 [AP-12 Manager] screen descriptions	32
■ Settings	32
■ IP Configuration	36
■ MAC security	37
■ Wep security	38
■ Show Station	40
■ Version Information	41
■ Options	42
4-2 The default settings	43
4-3 Uninstalling [AP-12 Manager]	44

4-1 [AP-12 Manager] screen descriptions

■ Settings

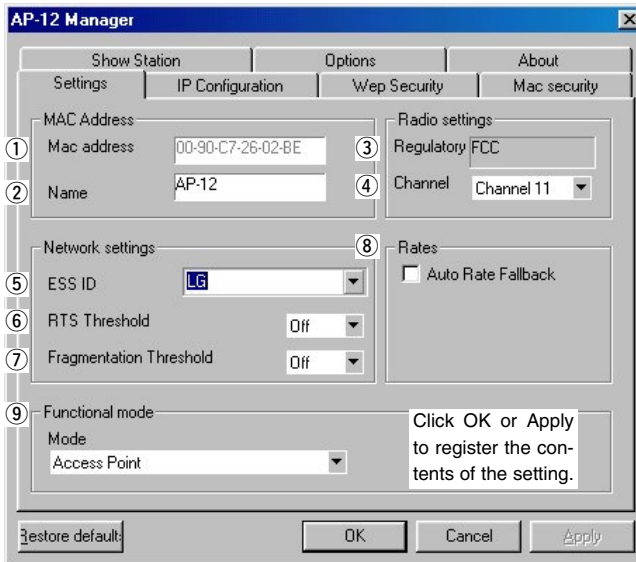

- ① MAC address..... Shows the AP-12's MAC address.
The address is also mentioned on the serial number seal.
- The MAC address cannot be changed.
 - The MAC address is a unique address that is assigned to each device in the network.
- ② Name Enter the desired alphanumeric name to discriminate one AP-12 from another.
The name should be unique, and up to 29 characters can be used.
- ③ Regulatory Shows the regulatory name of the AP-12.
The regulatory name cannot be changed.

- ④ Channel

Select the desired channel number for the wireless communication. (default: 11)

 - The same channel number should be selected with another AP-12 when Bridge mode A or C is selected.
 - Wireless LAN clients will detect the channel of the AP-12 automatically and select it by themselves in Bridge mode B operation.
- ⑤ ESS ID

Enter the desired ID for wireless network groups. Up to 32 alphanumeric characters (case sensitive) can be entered (default: LG).

 - The ID entering is not possible when Bridge mode A or C is selected in ⑨ Functional mode.
- ⑥ RTS Threshold

Select the packet size for negotiation of data transmission from 500 bytes, 1000 bytes and Off. When the transmission packet size exceeds the selected value, Rts (Request to send) and Cts (Clear to send) data is transmitted to prevent communication speed deterioration from the “Hidden wireless client” access. See p. 35 for “Hidden wireless terminals”.
- ⑦ Fragmentation
Threshold

Select the packet size for the fragmentation operation. (default:OFF)

This setting improves total data transmission speed by sending fragmented data, not all, when the communication is disconnected, such as that caused by interference.
- ⑧ Rate

Select the data transmission speed from 11 Mbps (fixed) and automatic. (default:11 Mbps/fixed)

When automatic is selected (“✓” mark appears), the data transmission speed is selected from 11, 5.5, 2 and 1 Mbps automatically according to the conditions.

4 AP-12 MANAGER

4-1 [AP-12 Manager] screen descriptions

■ Settings (continued)

⑨ Functional mode ...

NOTE: When “Auto-matic” is selected in IP configuration (p. 36), bridge mode B is not selectable.

Select the wireless LAN functional mode.

(default: Access Point)

See Chapter 1-1 (p. 2) for details of each mode.

The following items appear when you select Bridge Mode A or B.

• Remote MAC Address

“Remote MAC Address” appears when **Bridge Mode A** (Peer-to-Peer) is selected.

Enter the desired MAC address into the text box at right for communication.

• Preferred Bssid

“Preferred Bssid” appears when **Bridge Mode B** (Client Mode) is selected.

Enter the desired AP-12’s MAC address, prior to communication, when two or more AP-12s operating in access point mode are available.

◆ **Hidden wireless terminals**

During Access Point mode communication as shown below, wireless LAN terminal [A] and [C] cannot communicate directly, even when both terminal [A] and [C] can access AP-12 [B].

In such a case, terminal [A] is a “Hidden wireless terminal” for [C], and terminal [C] is a “Hidden wireless terminal” for [A].

When terminal [A] is accessing AP-12 [B], for example, to prevent the communication collision, the request-to-send (Rts) signal received by AP-12 [B] sends a clear-to-send (Cts) signal to both terminal [A] and [C] repeatedly. Then terminal [C] recognizes that AP-12 is busy, and forbidding to access to AP-12 [B].

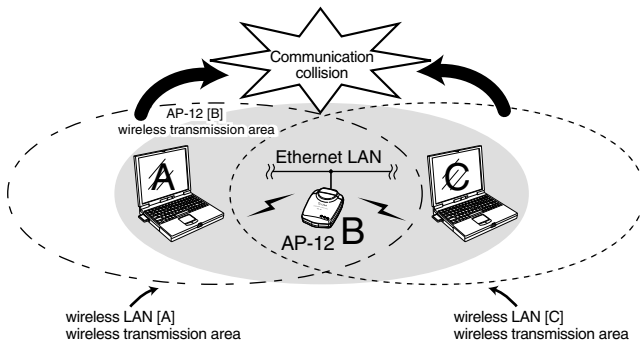

◆ **Communication channels**

Set the communication channels of network groups at least four channels apart to avoid interference if two or more access points are available in the wireless transmission area.

Otherwise, interference may occur due to partial overlap in bandwidth as shown below. Channel settings of 1-6-11, for example, eliminates the possibility of interference.

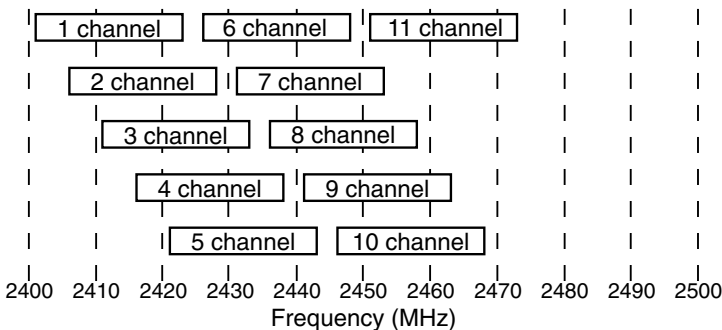

4 AP-12 MANAGER

4-1 [AP-12 Manager] screen descriptions (continued)

■ IP Configuration

Set the IP address of the AP-12.

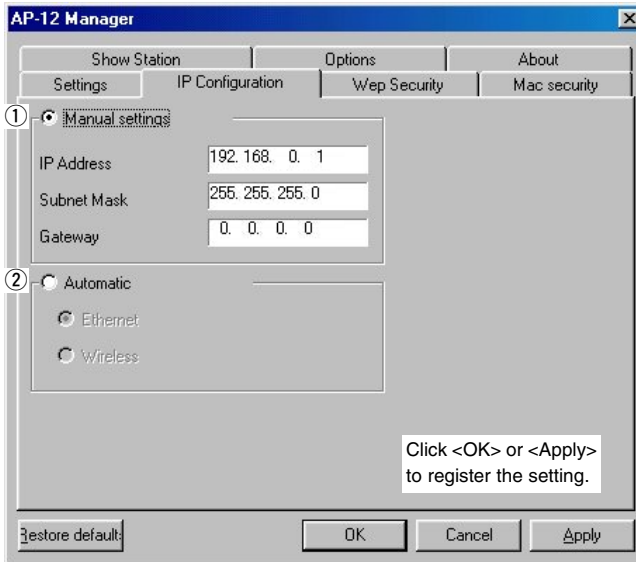

① Manual settings.....

Set the desired IP address, Subnet mask and Gateway.

- The default settings are;
IP Address : 192.168.0.1
Subnet mask : 255.255.255.0
Gateway : 0.0.0.0
- The end of Subnet Mask can not be changed.
- It is not necessary to set Gateway.

② Automatic

Obtain an IP address from the DHCP server in the LAN. (default)

- Ethernet (default)
Obtain an IP address via wired LAN.
- Wireless
Obtain an IP address via Wireless LAN.

NOTE: When Bridge mode B is selected in Settings screen (p. 34), "Automatic" is not selectable.

■ **MAC security**

Sets MAC address security function.

This function can only be set when the access point mode or Bridge mode C is selected.

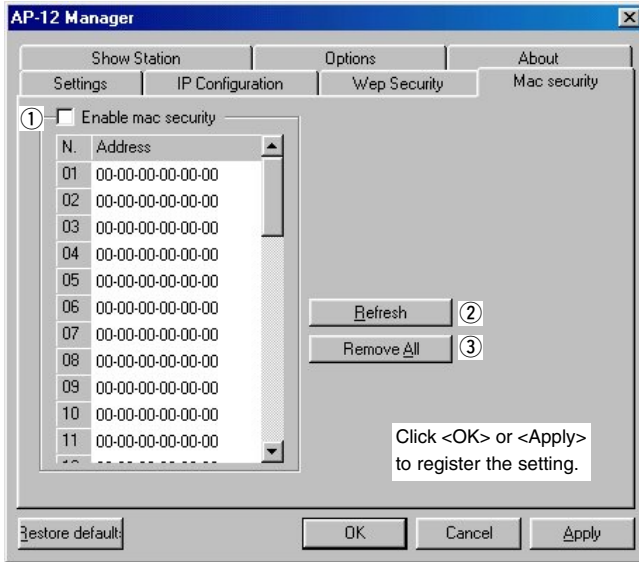

① Enable mac security
.....

Turns the MAC security ON and OFF. (“✓” mark appears when set to ON.)

(default: OFF)

When the Mac security is turned ON, the wireless devices to which a MAC address is registered only can access the AP-12.

Up to 40 MAC addresses can be registered.

② Refresh

Displays the contents of the settings.

③ Remove All

Deletes all registered MAC addresses.

Click <Remove All > then <Apply>, when deleting all settings.

4 AP-12 MANAGER

4-1 [AP-12 Manager] screen descriptions (continued)

■ Wep Security

(Setting for data security.)

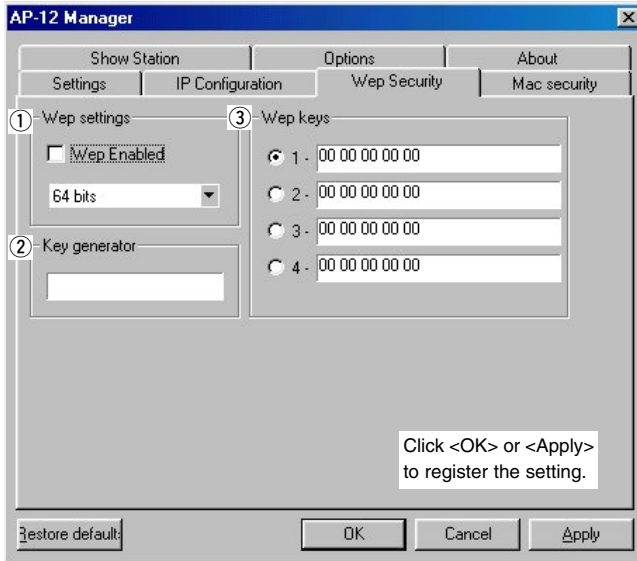

① Wep settings

Turn the WEP transmission data encryption ON and OFF, and select the encryption level from 64-bit and 128-bit. (“✓” mark appears when the encryption is set to ON.) (default: OFF)

- 64 bits/128 bits

Encrypt the character string, entered in ② key generator, at 64-bit/128-bit.

② Key generator

Enter the desired character string for data encryption and decryption.

Up to 32 alphanumeric characters (case sensitive) can be entered.

The generated four keys (may differ according to the selected bit number in ① Wep setting), are displayed in the Wep keys text boxes.

- The same character string should be entered for all the AP-12's or terminals, to be accessed.
- After clicking <OK>, all WEP key indications in the Wep keys text boxes return to “00 00 00 00 00.”

③ Wep keys

Select the desired WEP key number for data encryption. (default:1)

The desired key number can be selected between the AP-12 and another AP-12 or terminal.



A key, generated by the key generator, is displayed in the text boxes. However, the desired keys in hexadecimal numbers can be entered into the text boxes directly when no key generator is set.

The lower 40-bit (10 hexadecimal numbers) or the lower 104-bit (26 hexadecimal numbers) can be entered when 64 bits or 128 bits is selected, respectively.

- No key generator is displayed when the desired key is entered into the key text boxes directly.
- The same key content should be entered into the key number that is selected for another AP-12 or terminal, as shown in the example 1 and 2.

No communication is made when different contents are entered into the key number that is selected for another AP-12 or terminal, as shown in the example 3.

◇ WEP Key Setting Examples– 64-bit encryption

<p>Example 1</p>	<input type="radio"/> 1 - EF 04 9D 48 67 <input checked="" type="radio"/> 2 - 35 8B 80 45 94 <input type="radio"/> 3 - FD 99 76 BC 8B <input type="radio"/> 4 - 8F E0 7B D2 2A	<p>Two-way communication enable</p> 	<input type="radio"/> 1 - 8F E0 7B D2 2A <input checked="" type="radio"/> 2 - 35 8B 80 45 94 <input type="radio"/> 3 - FD 99 76 BC 8B <input type="radio"/> 4 - EF 04 9D 48 67
<p>Example 2</p>	<input type="radio"/> 1 - EF 04 9D 48 67 <input checked="" type="radio"/> 2 - 35 8B 80 45 94 <input type="radio"/> 3 - FD 99 76 BC 8B <input type="radio"/> 4 - 8F E0 7B D2 2A	<p>Two-way communication enable</p> 	<input type="radio"/> 1 - 8F E0 7B D2 2A <input checked="" type="radio"/> 2 - 35 8B 80 45 94 <input checked="" type="radio"/> 3 - FD 99 76 BC 8B <input type="radio"/> 4 - EF 04 9D 48 67
<p>Example 3</p>	<input checked="" type="radio"/> 1 - EF 04 9D 48 67 <input type="radio"/> 2 - 35 8B 80 45 94 <input type="radio"/> 3 - FD 99 76 BC 8B <input type="radio"/> 4 - 8F E0 7B D2 2A	<p>Communication disable</p> 	<input type="radio"/> 1 - 8F E0 7B D2 2A <input type="radio"/> 2 - 35 8B 80 45 94 <input type="radio"/> 3 - FD 99 76 BC 8B <input checked="" type="radio"/> 4 - EF 04 9D 48 67

NOTE: Above screens shows the condition before clicking <Apply>. The display returns to “00 00 00 00 00” after clicking <Apply>.

4 AP-12 MANAGER

4-1 [AP-12 Manager] screen descriptions (continued)

■ Show Station

Shows all MAC address for registered terminals during access point mode operation.

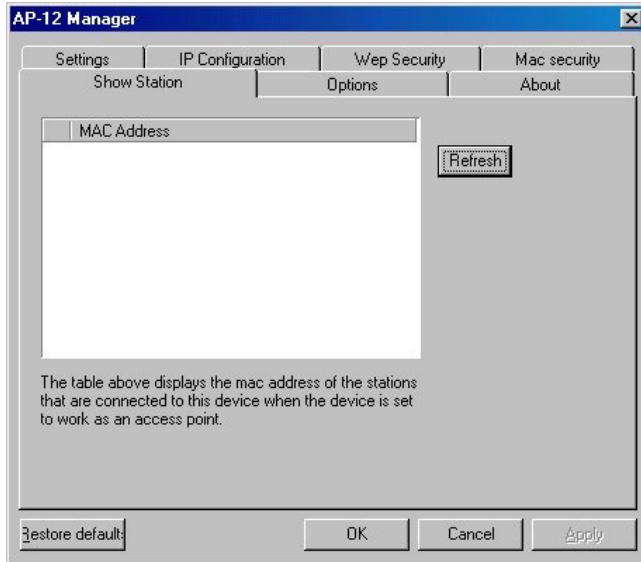

Refresh

Renews the MAC address indication.

- [AP-12 Manager] recognizes a terminal is still connected for 5 minutes (approx.) after the disconnection.

■ Version Information

Shows the version number for the [AP-12 Manager] and the firmware.

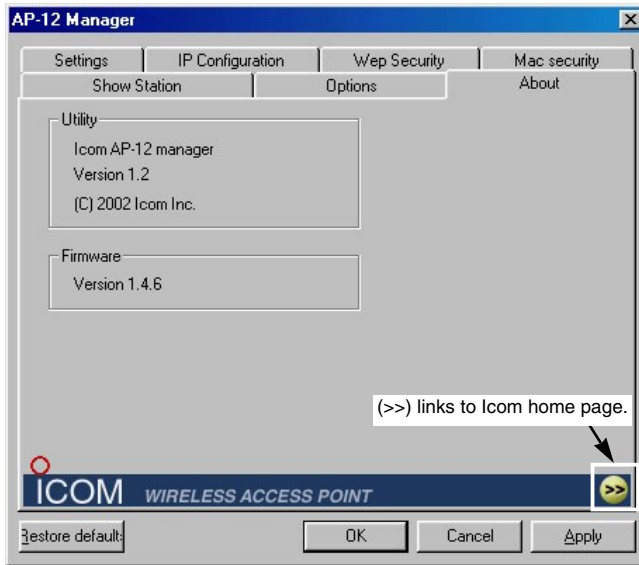

4 AP-12 MANAGER

4-1 [AP-12 Manager] screen descriptions (continued)

■ Options

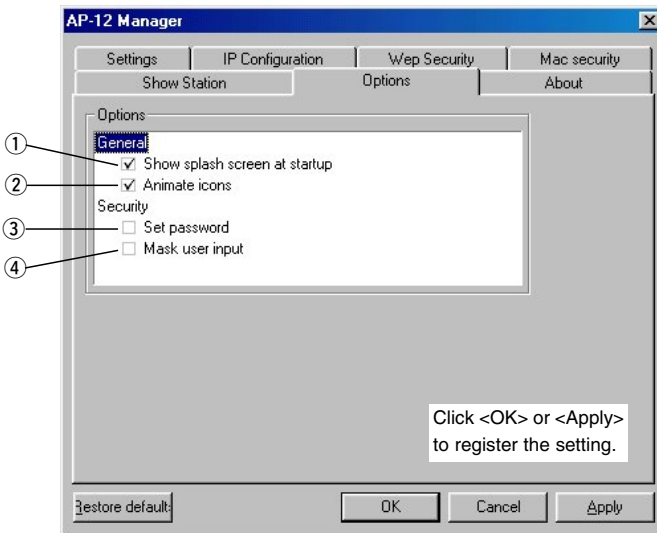

- ① Show splash screen at startup Turns the splash screen ON and OFF. The screen appears when starting up [AP-12 Manager]. (default: /Display)
- ② Animate icons Selects [AP-12 Manager] icon indicating type from flashing or non-flashing. The icon flashes when checked (“✓” appears). (default: /Flash)
- ③ Set password..... Turns the password function ON and OFF when starting up [AP-12 Manager]. The password setting screen is displayed when re-starting [AP-12 Manager] after setting to ON (“✓” appears). Enter the desired password within 32 characters (case sensitive). Once the password is set, password entry is necessary for starting up [AP-12 Manager]. (default: OFF)
- ④ Mask user input ... Selects the entered key generator and WEP key indication type. The entered characters are displayed with asterisks (*) when this item is checked (“✓” appears). (default: OFF)

4 AP-12 MANAGER

4-3 Uninstalling [AP-12 Manager]

This section describes [AP-12 Manager] uninstallation. (Windows XP)

When your PC uses an operating system other than Windows XP, follow the on-screen messages or instructions for the OS to uninstall.

[Procedure]

- ① Click <Start> and select [Control Panel] from the [Settings] menu.
Double-click <Install/Uninstall>.
- ② Click [Add or Remove Programs] and select [ICOM AP-12 Manager] and click <Change/Remove...>.

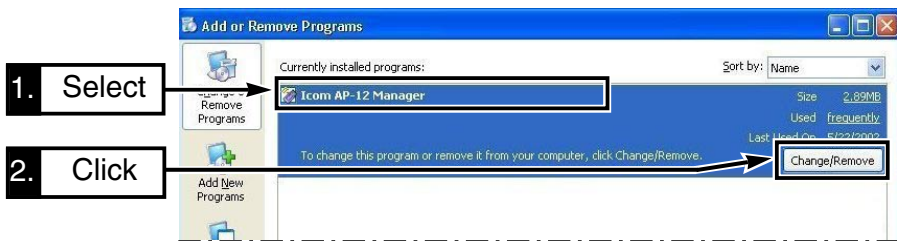

- ③ [AP-12 Manager] Uninstall Wizard starts automatically.
Click <Uninstall>.

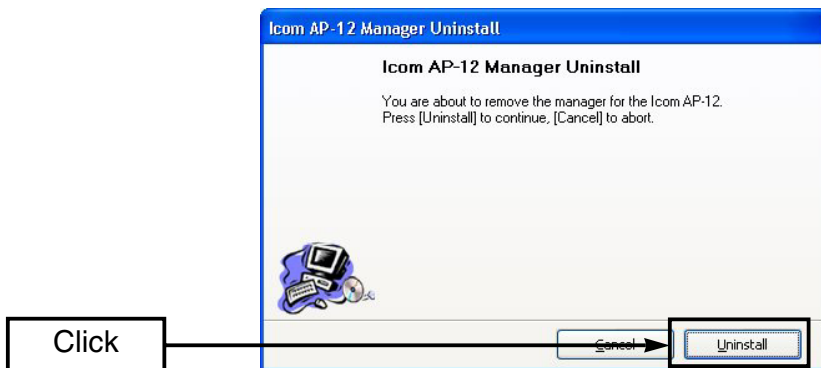

The uninstall wizard appears when operating according to the installation instruction, described in Installing [AP-12 Manager] (pgs.11, 25).

After uninstalling, install [AP-12 Manager] with the install wizard appeared after the uninstallation.

This chapter describes the minimum setting requirements in each functional mode with a setting example.

5-1 Access point mode	46
5-2 Bridge mode A (Peer to Peer)	47
5-3 Bridge mode B (Client Mode)	48
5-4 Bridge mode C (Multi-site)	49

<Function List >

The functions available will change according to the selected functional mode.

✓: Available N/A: Not Available

	Access point mode	Bridge mode A	Bridge mode B	Bridge mode C
Roaming	✓		N/A	
DHCP client	✓	✓	N/A	✓
WEP security	✓	✓	✓	✓
MAC security	✓		N/A	✓
ESS ID	✓	N/A	✓	N/A

5-1 Access point mode

Set the AP-12 and the PC as in the network shown at right.

- IP address of the PC should already be set. (See Chapter 2 or 3)
- See Chapter 4 (p. 31) for [AP-12 Manager] details.

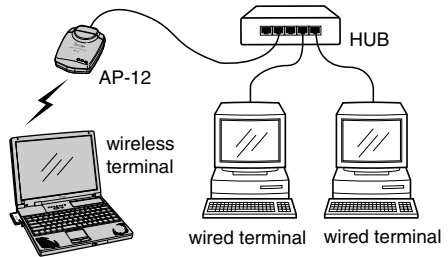

1. Setting the AP-12

Set the following items in [AP-12 Manager] Settings screen. (pgs. 33, 34)

- **ESS ID:**
Set the same ID as the wireless terminal.
- **Channel:**
Set the desired channel.
- Set the channel at least four channels apart to avoid interference if another AP-12(s), operating on an other channel(s), are within the transmission area.
- **Functional mode:**
Select "Access Point".
Check the "Auto Rate Fallback" ("✓" appears) when communication is unstable.

2. Setting the wireless terminal

Set the following items in the wireless LAN card.

- **Network settings:**
Select "Infrastructure".
- **ESS ID:**
Set the same ID as the AP-12.
- **Tx rate:**
Select "Automatic".

5-2 Bridge mode A (Peer-to-Peer)

Set the AP-12 and the PC as in the network shown at right.

- IP address of the PC should already be set. (See Chapter 2 or 3)
- See Chapter 4 (p. 31) for [AP-12 Manager] details.

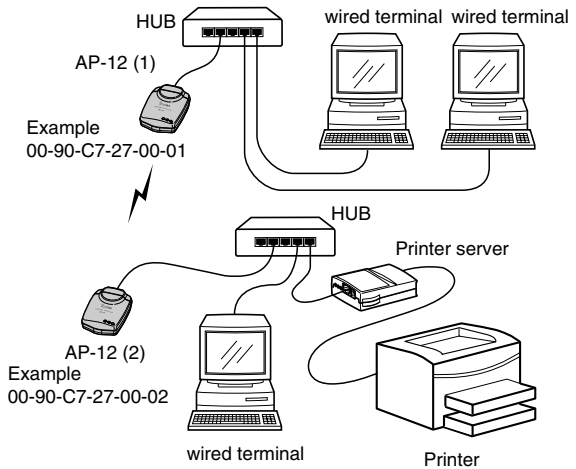

1. Common settings

Set the following items in [AP-12 Manager] Settings screen (pgs. 33, 34).

- **Channel:**

Set the desired channel for both the AP-12s.

- Set the channel at least four channels apart to avoid interference if another AP-12(s), operating on an other channel(s), are within the transmission area.

- **Functional mode**

Select "Bridge Mode A".

- Check the "Auto Rate Fallback" ("✓" appears) when communication is unstable.

2. Individual settings

Set the partner's MAC address in [AP-12 Manager] Settings screen. (p. 32)

- **Remote MAC Address**

Set the AP-12 (2)'s MAC Address, "00-90-C7-27-00-02", to the AP-12 (1).

Set the AP-12 (1)'s MAC Address, "00-90-C7-27-00-01", to the AP-12 (2).

5-3 Bridge mode B (Client Mode)

Set the AP-12 and the PC as in the network shown at right.

- IP address of the PC should already be set. (See Chapter 2 or 3)
- See Chapter 4 (p. 31) for [AP-12 Manager] details.
- Follow the instruction manual of the printer server when connecting to the AP-12. (Usually, a crossover cable is used.)

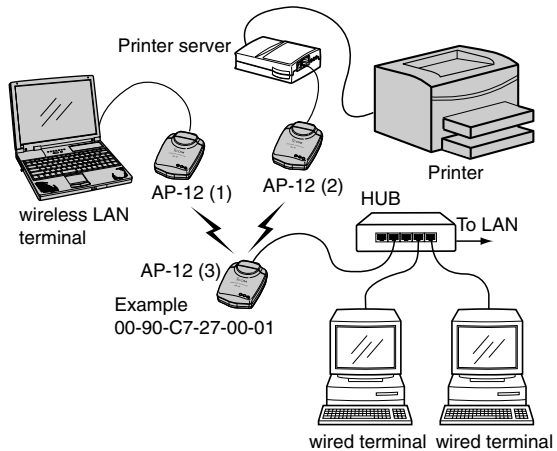

1. Common setting

Set the following item in [AP-12 Manager] Settings screen. (p. 33)

• ESS ID:

Set the same ID.

- Check the "Auto Rate Fallback" ("✓" is appears) when communication is unstable.

2. AP-12 (1) and (2) settings

Set the following items in [AP-12 Manager] Settings screen. (p. 34)

• Functional mode:

Select "Bridge Mode B."

• Preferred BSS ID:

Set the AP-12 (3)'s MAC address, "00-90-C7-27-00-01," prior to communication with the AP-12 (3).

3. AP-12 (3) settings

Set the following items in [AP-12 Manager] Settings screen. (pgs. 33, 34)

• Channel:

Select the desired channel.

- Set the channel at least four channels apart to avoid interference if another AP-12(s), operating on an other channel(s), are within the transmission area. (p. 35)

• Functional mode:

Select "Access Point."

- AP-12 must be used for the access point when other AP-12s (AP-12 (1) and (2), in this case) are used in "Bridge Mode B."

5-4 Bridge mode C (Multi-site)

Set the AP-12 and the PC as in the network shown at right.

- IP address of the PC should already be set. (See Chapter 2 or 3)
- See Chapter 4 (p. 31) for [AP-12 Manager] details.
- Follow the instruction manual of the printer server when connecting to the AP-12. Usually, a crossover cable is used.)

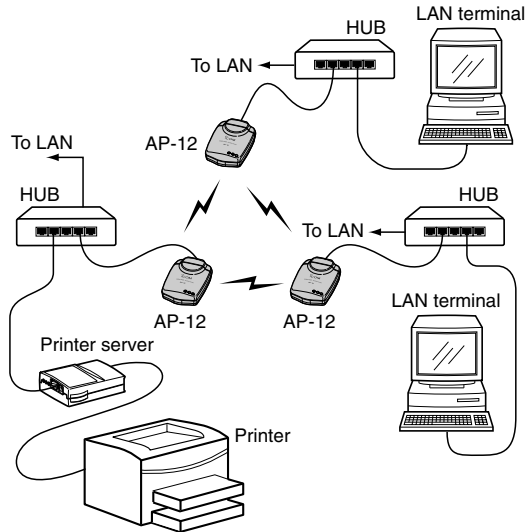

All AP-12s settings

Set the following items in [AP-12 Manager] Settings screen. (pgs. 33, 34)

• Channel:

Set the desired channel.

- Set the channel at least four channels apart to avoid interference if another AP-12(s), operating on an other channel(s), are within the transmission area. (p. 35)

• Functional mode:

Select "Bridge Mode C."

- Check the "Auto Rate Fallback" ("✓" appears) when communication is unstable.



This chapter describes about changing the PC's IP address.

Changing of the PC's IP address is required when setting up a LAN used with the AP-12 with a fixed IP setting and a PC.

The default IP address is used with the AP-12 (192.168.0.1) for the setting description in this chapter.

Changing the PC's IP address is not necessary when the PC has been connected to a LAN with a DHCP server, and obtains an IP address from the DHCP server.

6-1 For Windows XP	52
6-3 For Windows 98/98SE/Me.....	54
6-2 For Windows 2000	55

[Setting the IP address and subnet mask]

- Set a unique IP address for each PC in the network group.
- Set the same subnet mask for all PCs in the network group.
- Set private addresses. 192.168.0.0 to 192.168.255.255 are used for a small network group (up to 253 terminals). However, never assign the network address (192.168.XXX.0) and broadcast address (192.168.XXX.255) to the terminal. (XXX: 0 to 255)

See the following address examples of a wireless LAN comprised of three PCs.

Wireless terminal A: 192.168.0.10 (subnet mask: 255.255.255.0)

Wireless terminal B: 192.168.0.11 (subnet mask: 255.255.255.0)

Wireless terminal C: 192.168.0.12 (subnet mask: 255.255.255.0)

6 IP CONFIGURATION

6-1 For Windows XP

[Procedure]

- ① Boot up the PC.
 - The log-on screen appears.
- ② Log on as the **administrator**.
- ③ After the PC has booted up, click <Start> and select [Control Panel] from the [Settings] menu.
- ④ Click [Network and Internet Connections].
- ⑤ Click [Network Connection].
- ⑥ Right-click [Local Area Connection] icon and click [Properties] in the menu that appears.

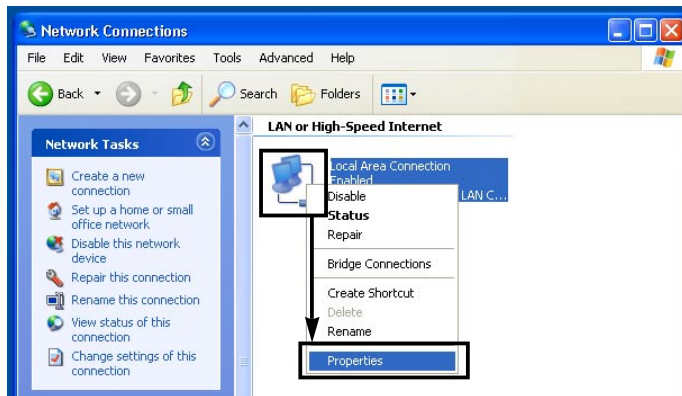

- ⑦ Click [Internet Protocol (TCP/IP)] and then [Properties].

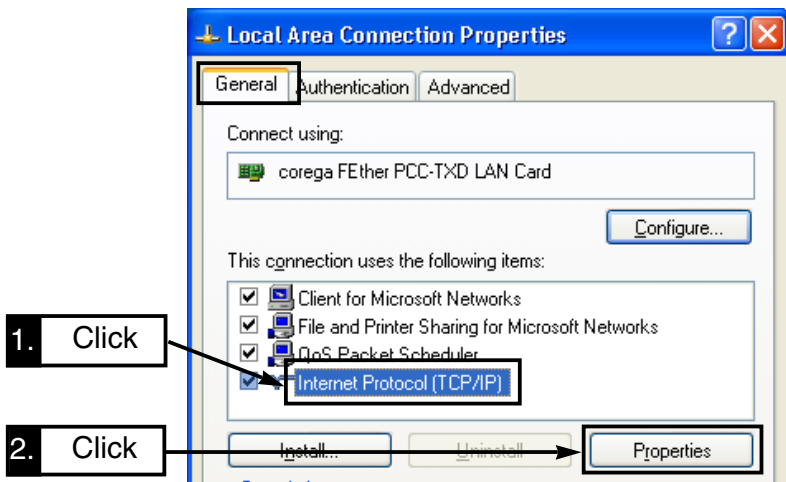

- ⑧ Select [Use the following IP address] and enter the IP address and subnet mask, then click [OK] to enable the specified settings.

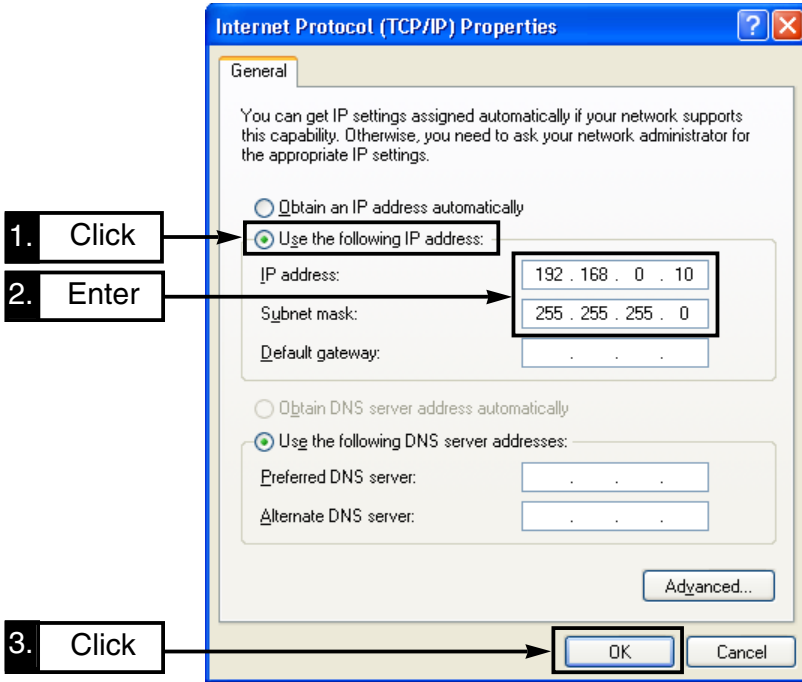

6-2 For Windows 98/98SE/Me

[Procedure]

1. Click <Start> and select [Control Panel] from the [Settings] menu.
Click [Network].
2. Verify that [TCP/IP->The Ethernet card name] is displayed in the screen.
Click [TCP/IP] then, [Properties].

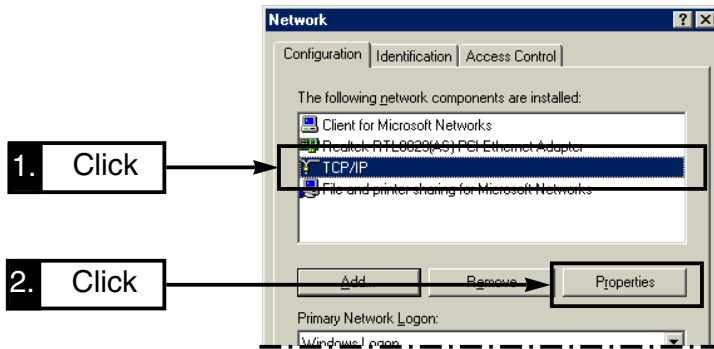

3. Click the [Specify an IP address] radio button, enter the IP address and subnet mask and click <OK>.

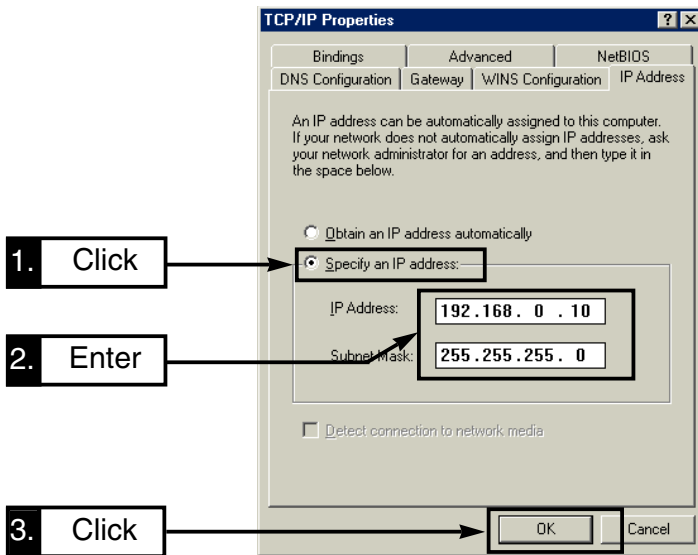

4. When the message "Reboot now?" appears on the screen, click <Yes>.
After rebooting, the specified settings are available.

6-3 For Windows 2000

[Procedure]

- ① Start the PC.
 - The Windows 2000 log-on screen appears.
- ② Log on as the **Administrator**.
- ③ Click <Start> and select [Network and Dial-up Connections] from the [Settings] menu.
Then, double click [Local Area Connection] icon which shows your Ethernet card name.

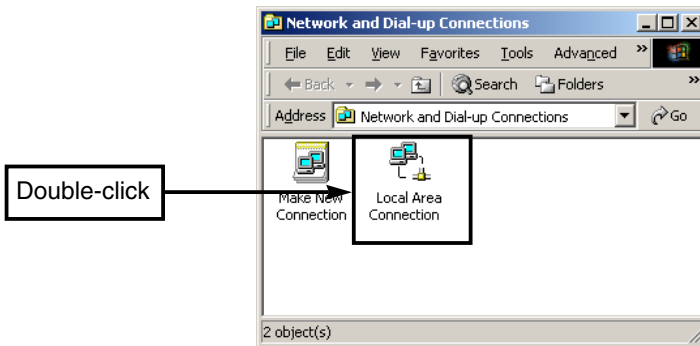

- ④ Click [Properties].

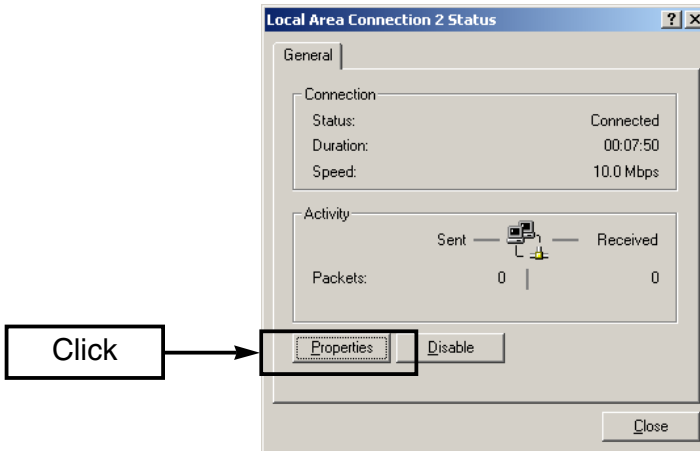

6 IP CONFIGURATION

6-3 For Windows 2000 (Continued)

- ⑤ Click [Internet Protocol (TCP/IP)] and then [Properties].

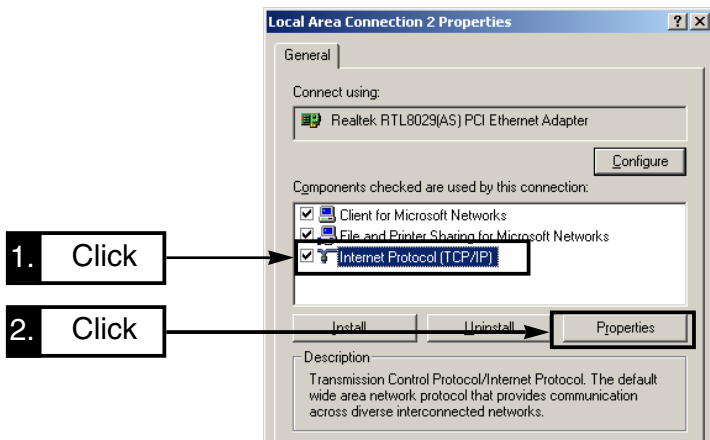

- ⑥ Select [Use the following IP address] and enter the IP address and subnet mask, then click [OK] to enable the specified settings.

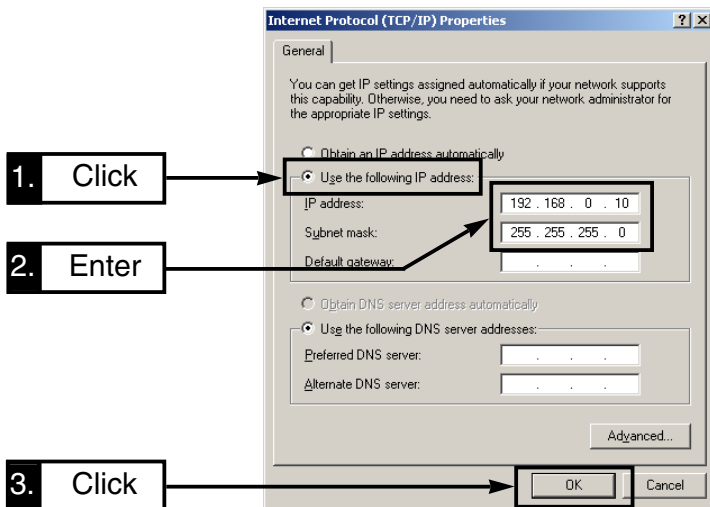

This chapter describes additional matters about the AP-12.

7-1 Troubleshooting	58
7-2 Connecting the AP-12 and HUB	60
7-3 Verifying the connection to the AP-12	60
7-4 Failure in searching for the AP-12	61
7-5 IP address confirmation	64
■ Windows XP	64
■ Windows 98/98SE/Me	65
■ Windows 2000	65
7-6 Connection to the router type modem	66
7-7 Specifications	68
■ Specifications for Ethernet Plug.....	69
■ Wireless LAN for the AP-12	69
7-8 Glossary	70

7-1 Troubleshooting

If your AP-12 seems to be malfunctioning, please check the following points before sending it to a service center.

PROGRAM	POSSIBLE CAUSE	SOLUTION	REF.
NO power comes ON.	DC Power cable or AC adapter is improperly connected.	Re-connect the DC power cable or AC adapter correctly.	pgs. 10, 16
Television interference (TVI) or broadcast interference (BCI) occurs.	<ul style="list-style-type: none"> The AP-12 is too close to a television set or radio. 	<ul style="list-style-type: none"> Keep the AP-12 away from a television set or radio. 	p. 6
Communication with the AP-12 has failed.	An IP address has not been obtained from the DHCP server.	Turn the AP-12 power OFF. After waiting a few seconds, turn power ON again. Then, reboot the PC(s).	—
Wired LAN indicator does not light.	<ul style="list-style-type: none"> Incorrect Ethernet cable is used. The HUB power is OFF, or the patch cable is connected to the cascade port of the HUB. 	<ul style="list-style-type: none"> Connect the correct Ethernet cable according to the connecting condition. Turn the HUB power ON, or connect the patch cable to the cross port of the HUB. 	p. 16 pgs. 10, 60
[AP-12 Manager] unable to be installed to Windows XP/2000.	The PC is not logged on as the administrator.	Log on as the administrator.	pgs. 11, 25
Menu screen does not appear after inserting the CD.	Auto Run function does not function.	Double-click "AutoRun.exe" contained in the CD.	pgs. 11, 17, 25
No connection to the AP-12 via [AP-12 Manager].	The network part of IP address for both AP-12 and PC are different.	<ul style="list-style-type: none"> When the AP-12 is connected to a LAN: Turn the AP-12 power OFF. After waiting a few seconds, turn power ON again. Then start [AP-12 Manager]. When the AP-12 is connected to the PC: Quit [AP-12 Manager], set the PC's IP address again using the [Easy Setting Wizard], then restart [AP-12 Manager]. 	p. 13 p. 17

PROGRAM	POSSIBLE CAUSE	SOLUTION	REF.
Connection to the AP-12 has failed after restoring.	The network part of the AP-12's IP address is different from the PC's because of the restoring.	Reset the AP-12's IP address using [Easy Setting Wizard] or the [AP-12 Manager].	pgs. 17, 61
No IP address is assigned from the DHCP server.	<ul style="list-style-type: none"> • Ethernet cable is not connected to wired LAN within 30 sec. from turning the AP-12 power ON. • "Manual settings" is selected. • No DHCP server is available in the connected wired LAN. 	<ul style="list-style-type: none"> • Turn the AP-12 power OFF. After waiting a few seconds, turn power ON again, then check the IP address. • Select "Automatic" and connection method. • Confirm the DHCP server availability. 	<p>p. 10</p> <p>p. 36</p> <p>—</p>
Wireless LAN terminal(s) unable to obtain an IP address from the DHCP server via the AP-12.	<ul style="list-style-type: none"> • No DHCP server is available in the connected wired LAN. • Fixed IP address is set to wireless LAN card. • "Bridge Mode B" is selected as the Functional mode. 	<ul style="list-style-type: none"> • Confirm the DHCP server availability. • Set the wireless LAN card to obtain an IP address from the DHCP server. • Select "Access Point Mode", "Bridge Mode A" or "C". 	<p>—</p> <p>p. 36</p> <p>p. 34</p>
"Automatic" is impossible to set.	"Bridge Mode B" is selected as the functional mode.	Select "Access Point Mode", "Bridge Mode A" or "C".	p. 34
[AP-12 Manager] or [Easy Setting Wizard] cannot find the AP-12.	<ul style="list-style-type: none"> • The network part of the AP-12's IP address is different from the PC's. • In case of using Windows XP, "Enabled, Firewallled" is indicated on the [Local Area Connection] icon. • The personal firewall software is activated. 	<ul style="list-style-type: none"> • Set the AP-12's IP address using [AP-12 Manager]. • Right-click [Local Area Connection] icon and click [Properties]. Then, select [Advanced] tab in the menu. Clear the [Internet Connection Firewall] check box. • Set the software to enable access to the AP-12. *See the software's instruction manual or for details. 	<p>p. 62</p> <p>p. 52</p> <p>—</p>
Wireless communication is impossible.	ESS ID or WEP security setting is different between the units.	Set the same ESS ID or WEP security setting.	pgs. 33, 38
Communication with wireless LAN card via access point mode has failed.	"Adhoc" mode is selected with the wireless LAN cable.	Select "Infrastructure" mode.	—

7-2 Connecting the AP-12 and HUB

There are 2 ways to connect the AP-12 and HUB

◆ Connect to the Cross Port

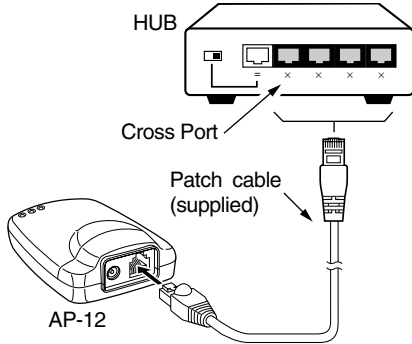

◆ Connect to the Cascade Port

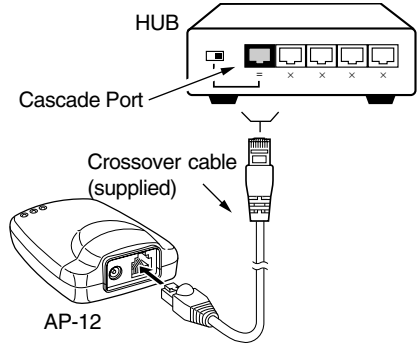

- A port with a switch may be available that switches the cascade port use as cross port, according to the HUB.
Be careful of the switch position and the connecting Ethernet cable type.

7-3 Verifying the connection to the AP-12

The IP packet received condition of the other PC can be easily checked by pinging when the IP address for each terminal is set correctly.

Enter the following command in the MS-DOS window to verify by pinging.

“ping xxx.xxx.xxx.xxx”

Enter the desired AP-12's IP address for “xxx.xxx.xxx.xxx” ☆ Ping command example

Four pings (echo request) are transmitted when executing the command, and the reply message will be received for each ping.

When no reply is received, check the terminal protocol availability, AP-12 or wireless LAN card settings, such as functional mode, ESS ID, etc.

The message “destination unreachable” will be displayed when both the IP address and subnet mask are different between source and destination terminals.

```
Microsoft Windows [Version 4.00]
(C) Copyright 1988 Microsoft Corporation

C:\WINDOWS>ping 172.20.11.40

Pinging 172.20.11.40 with 32 bytes of data:

Reply from 172.20.11.40: bytes=32 time<10ms TTL=32
Reply from 172.20.11.40: bytes=32 time<10ms TTL=32
Reply from 172.20.11.40: bytes=32 time<10ms TTL=32
Reply from 172.20.11.40: bytes=32 time<10ms TTL=32

Ping statistics for 172.20.11.40:
    Packets: Sent = 4, Received = 4, Lost = 0 (0% loss),
    Approximate round trip times in milli-seconds:
        Minimum = 0ms, Maximum = 0ms, Average = 0ms

C:\WINDOWS>
```

7-4 Failure in searching for the AP-12

Manual IP address setting is necessary when no AP-12 is found (the following screen appears) using [Easy Setting Wizard] or [AP-12 Manager], even if the connection between the AP-12 and the PC is correct.

- The following screen may take 30 sec. or more to appear.

◇ When using [Easy Setting Wizard]



◇ When using [AP-12 Manager]



[Procedure]

- ① Connect the PC and the AP-12 directly using the supplied crossover cable.

NOTE: DISCONNECT THE PC FROM THE EXISTING LAN.

When the PC is connected to the existing LAN, the AP-12 searches the DHCP server and uses the IP address obtained from the server according to the default setting.

- ② Start [AP-12 Manager] (p. 27).
- ③ Click <Set IP>.

- <Access point IP address setup tool> screen appears.

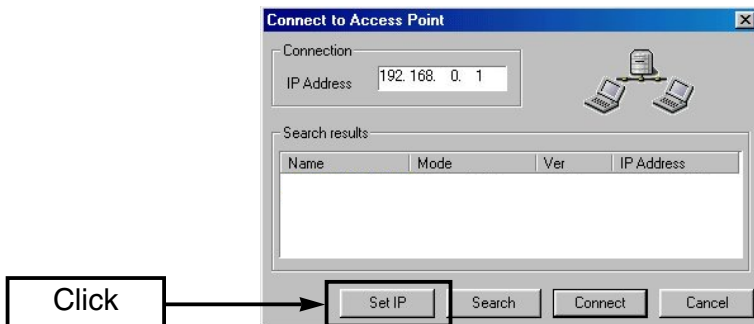

7 REFERENCES

7-4 Failure in searching for the AP-12 (continued)

- ④ Enter the desired IP address for the AP-12. The network part must be the same as the PC's IP address.
- ⑤ Enter the MAC address, described on the serial number seal.
- ⑥ Turn the power OFF.
After waiting a few seconds, turn the power ON again.
- ⑦ Click <Set IP>.

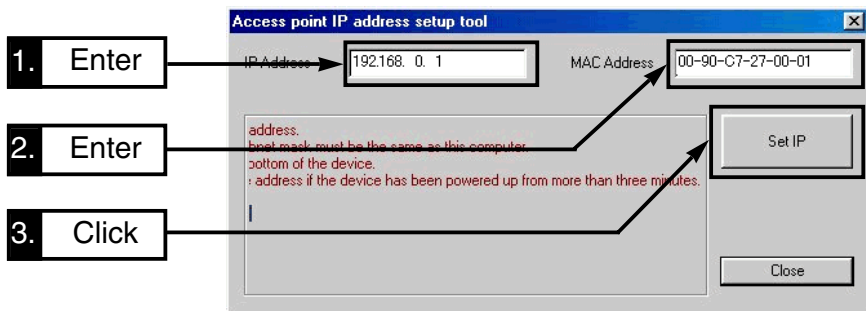

- ⑧ After 30 seconds (approx.: from clicking <Set IP>), click <Close> when the message stating that the setting is completed appears.
 - Do not turn the power OFF at this stage, as the setting will be erased and return to the condition in step ④.



⑨ Click <Search>.

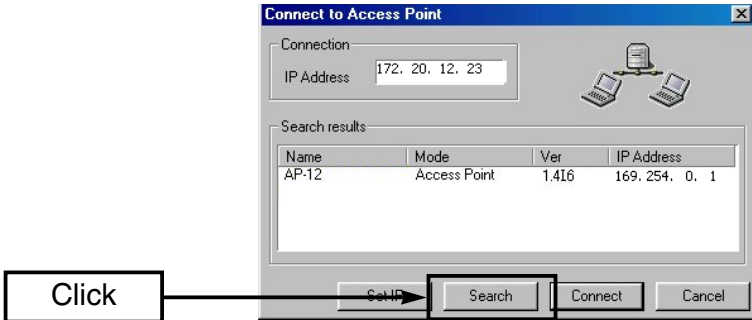

⑩ Select the AP-12, then click <Connect>.

- [AP-12 Manager] Settings screen appears.

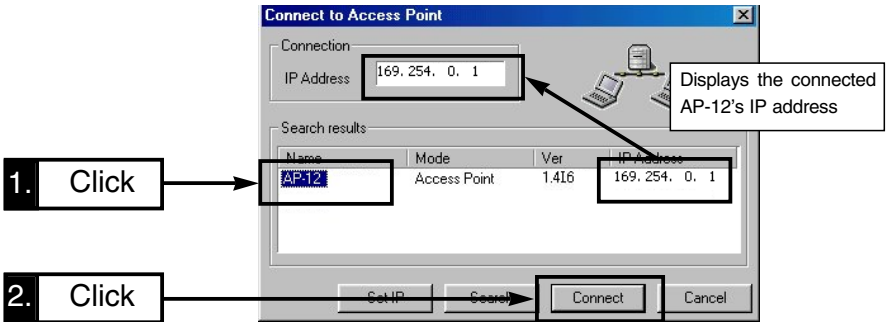

⑪ Click [IP Configuration] and set the AP-12's IP address as desired.

⑫ Click <OK> to register all the settings in the screen to the AP-12.

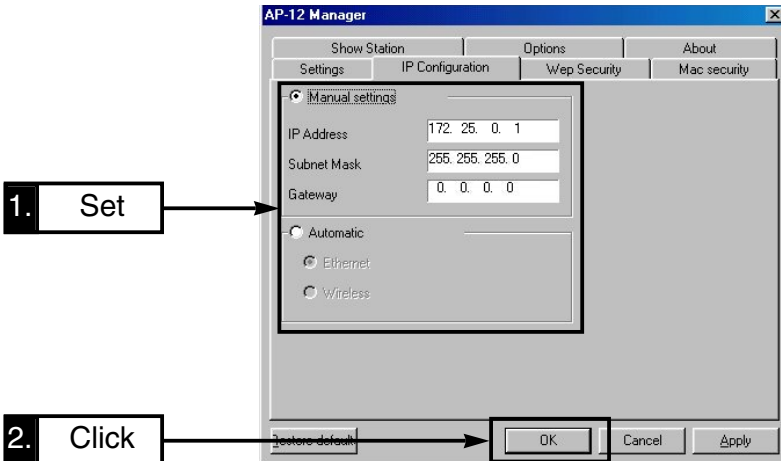

7-5 IP address confirmation

When the PC's IP address, including network part, is unknown, refer to the following instructions for confirmation.

- Reset the desired fixed IP address manually, or obtain an IP address from the DHCP server by connecting the PC to the LAN.

■ Windows XP

[Procedure]

- ① Click <Start> and select [Control Panel] from the [Settings] menu.
- ② Click [Network and Internet Connection].
- ③ Click [Network Connection].
- ④ Right-click [Local Area Connection] icon and click [Status] in the menu that appears.

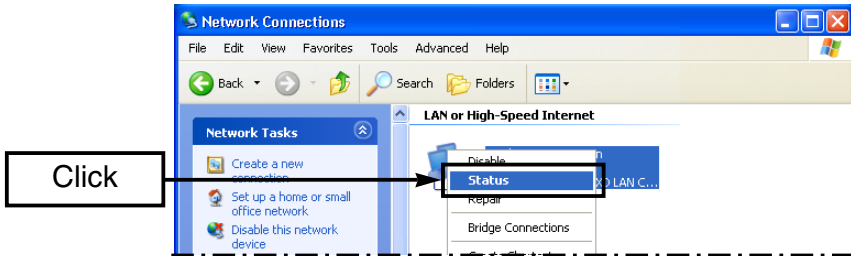

- ⑤ Click [Support] tab and confirm the assigned IP address, then click <Close>.
 - IP address assigned to the PC is displayed.

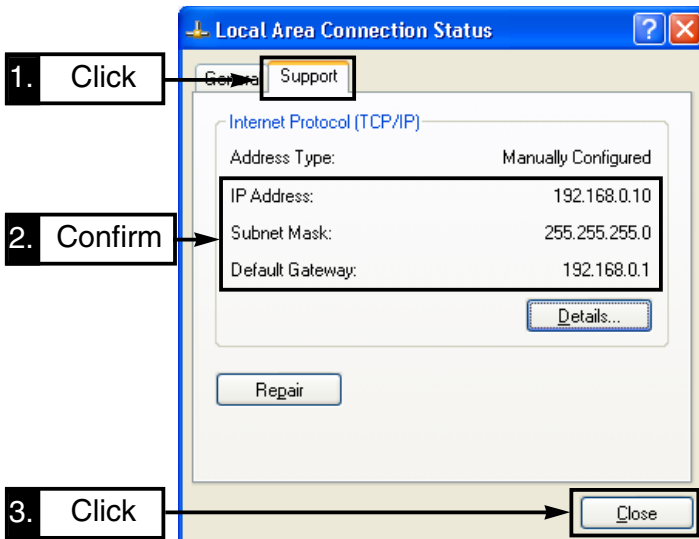

■ Windows 98/98SE/Me

[Procedure]

- ① Click <Start> and select [Run].
- ② Enter “winipcfg” and push [Enter].
- ③ Click [▼] and select the desired Ethernet card.
 - IP address assigned to the PC is displayed.

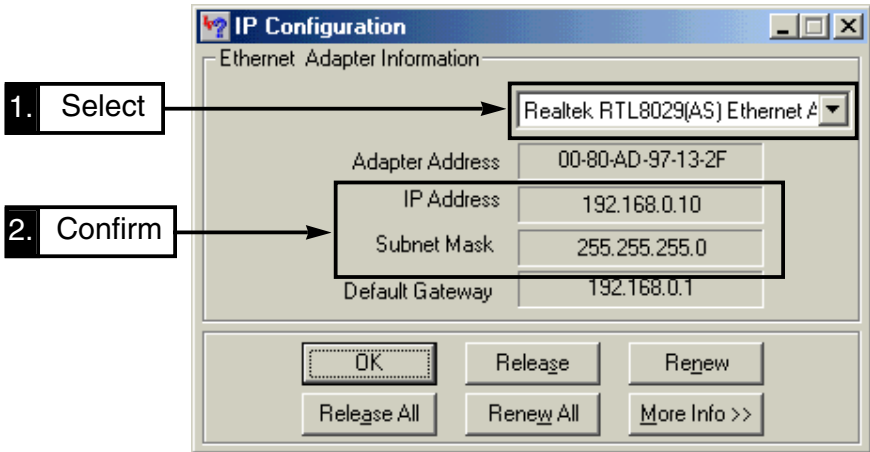

■ Windows 2000

[Procedure]

- ① Click <Start> and select [Program]. Then, click [Command prompt] from [Accessory] menu.
- ② Enter “ipconfig” and push [Enter].
 - IP address assigned to the PC is displayed.

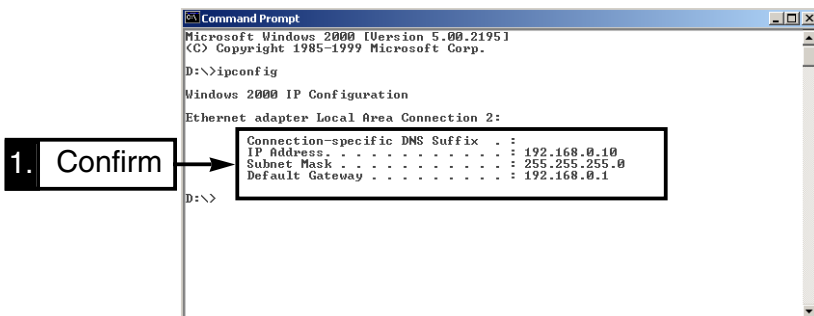

7-6 Connection to the router type modem

This section describes the connection between a router type modem and the AP-12 with the default setting.

There are different types of modems available—bridging type and router type.

IMPORTANT!: The AP-12 cannot be connected to a bridging type modem directly.

Bridging type modem: Usually connects one PC only and a global IP address is assigned to the PC.

Router type modem: Multiple PC's can be connected in the LAN via the HUB, and a private IP address is assigned to the PC.

◆ Wireless terminal preparation

After the following preparation is completed, wireless communication can be made with the AP-12 when using Icom's wireless LAN card.

- ① Prepare the PC to use the wireless LAN card.
- ② Install the supplied wireless LAN card driver.
 - Install other applications or utilities if supplied.
 - Refer to the instruction manual supplied with the LAN card for driver, applications and utilities installation.
- ③ Install [AP-12 Manager].
 - [AP-12 Manager] is used for IP address confirmation, AP-12 settings, etc.

◆ Connection to the router type modem

[Procedure]

- ① Connect the AP-12 and the router type modem using the supplied patch cable.
- ② Connect the AC adaptor to turn the AP-12 power ON.
 - The [POWER] indicator and the LAN indicator lights.
 - The [Wireless LAN] indicator flashes.

* Check the Ethernet cable connection and type if the LAN indicator does not light.
- ③ Start the PC and obtain an IP address from the modem automatically.

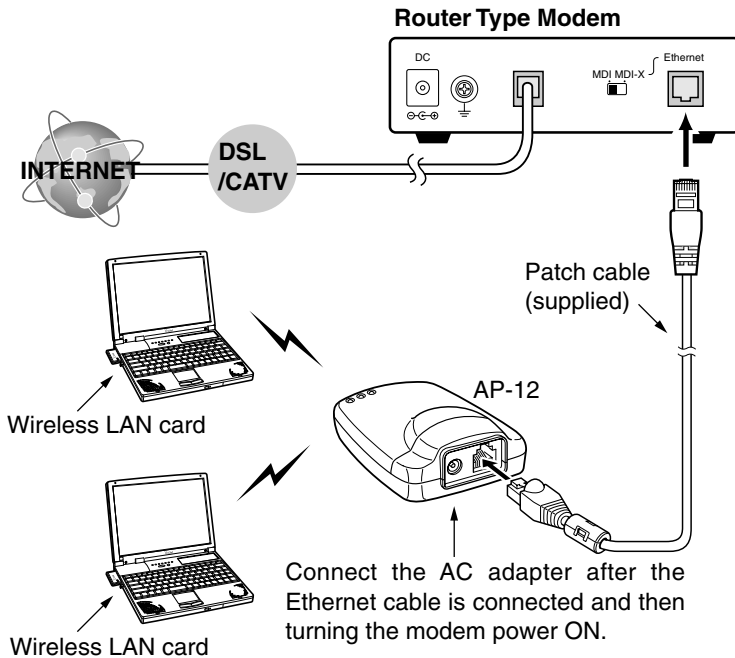

When communication has failed.

Turn the AP-12 power OFF. After waiting a few seconds, turn the power ON again. Then check the wireless terminal's IP address using [AP-12 Manager]. See the Chapter 7-5 (p. 64) for IP address confirmation.

7-7 Specifications

- **Input power** : 7.5 V DC $\pm 5\%$ (Negative grounding)
With supplied AC adapter is 90 to 132 V AC
- **Current drain** : Transmit 400 mA (typical)
Receive 350 mA (typical)
- **Operating temperature range** : 0 to +55°C; +32 to +131°F
- **Dimensions** : 100.0(W) \times 30.5(H) \times 70.0(D) mm
3¹⁵/₁₆(W) \times 1³/₁₆(H) \times 2³/₄(D) in
(projections not included)
- **Weight** : Approx. 90 g; 3.2 oz

- **Standard** : IEEE 802.11b
- **Compliance** : FCC Part 15, Canada RSS-139
- **Communication method** : Simple system
- **Spreading system** : Direct spread-spectrum communication system
- **Modulation** : DPSK, DQPSK
- **Frequency range** : 2400 to 2472 MHz
- **Available channels** : 11
- **Data transmission rate** : Max. 11 Mbps
- **Transmission range** : Approx. 30 m; 98.4 ft (indoor) at 11 Mbps
- **Security** : WEP (Wired Equivalent Privacy)
MAC (Media Access Control)
*MAC: [Bridge Mode A] and [Bridge Mode B] is not available.
- **Transmission power** : 100 mW or less
- **Reception sensitivity** : -76 dBm max. (frame error rate: 8%)
- **Demodulation method** : Digital demodulation (matched filter type)
- **Antenna type** : Diversity antenna (Built-in, non-replacement)

- **LAN interface** : Ethernet plug (Type RJ-45)
Based on IEEE802.3/10BASE-T
- **Transmission rate** : 10 Mbps
- **User interface** : Status indicators (Power, Wired LAN, Wireless LAN)
- **System requirements** : PC/AT compatible computer
Windows XP/Windows Me/Windows 2000/Windows 98 or Windows 98 SE.

- * **The stated specifications may be subject to change without notice.**
- * **The transmission range may vary depending on the transmission speed and the environmental conditions.**

■ Specifications for Ethernet Plug

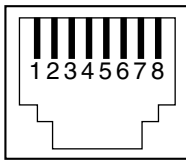

Modular plug type RJ-45 (8-pin) ×1

- | | |
|------------------|------------------|
| 1. Sending (+) | 2. Sending (-) |
| 3. Receiving (+) | 4. Not used |
| 5. Not used | 6. Receiving (-) |
| 7. Not used | 8. Not used |

- * **The stated specifications may be subject to change without notice.**

■ Wireless LAN for the AP-12

To communicate with the AP-12, the PC must be installed with Icom's Wireless LAN products for 11 Mbps.

- WEP security function is available with use during communication between Icom products.
- Bridge Mode is not available except with Icom products.
- When functional mode is Bridge Mode B, select the AP-12 as the access point.

7-8 Glossary

Access point

A generic name for devices or points to connect a wired LAN and wireless LAN.

BSS ID (Basic Service Set-Identifier)

Specified wireless LAN in MAC class.
The ID is uses the MAC address that is assigned to each network device.

Client

A generic name for network devices which relay packets at a MAC address level.

Crossover Cable

The transmission signal cable and receiving signal cable are cross wired to communicate correctly. Generally, used for connection between the PCs.

DHCP server

DHCP (Dynamic Host Configuration Protocol) is a protocol for a client to obtain necessary information automatically from a server on the TCP/IP network. The DHCP server controls IP address, default gateway, domain name, etc. as network information. AP-12, which has the DHCP server function, obtains the IP address, default gateway, DNS address, etc. when the DHCP client (Computer) has started.

ESS ID (Extended Service Set-Identifier)

A name for identification to create several network groups in a communication area in a wireless LAN. In the wireless network group which communicates to AP-12, the identifier of the wireless terminal must be the same as that of AP-12.

Ethernet

A LAN communication system developed by Xerox, DEC and Intel. 10BASE-T, 100BASE-TX, 10BASE-5, 10BASE-2, etc. are available depending on the cable type.

Global IP address

A unique address assigned to a device. One global IP address is assigned to only one device in the world.

HUB

A hub is required when the AP-12 and other devices are used to construct a network. 10BASE-T or 100 BASE-TX cable is used for the connection to the hub.

IP (Internet Protocol) address

32-Bit address to identify all the devices connected to a network in which the TCP/IP protocol is used. Usually, the IP address consists of four 8-bit numerical character strings of decimal notation (e.g., 192.168.0.1). A private IP address specified by a network administrator does not need to apply to an address administration agency or internet service provider. However, the network administrator must assign the private address according to the rules below. The private address must be converted into a global IP address when connecting to an external network. The IP addresses below can be used as the private IP address.

Class A: 10.0.0.0 to 10.255.255.255
Class B: 172.16.0.0 to 172.31.255.255
Class C: 192.168.0.0 to 192.168.255.255

LAN (Local Area Network)

A relatively small-sized network in the same floor or the same site.

MAC address (Media Access Control Address)

A physical address specified in individual wired or wireless products. The network device manufacturers control this address so that a unique number can be assigned to only one product in the world. Ethernet equipment and wireless LAN products send and receive a frame according to this MAC address.

Network

The state that some devices such as a server, workstation, Computer, etc. are connected to a communication system through a cable or ADSL line, to transmit data.

Packet

A unit to send/receive data. The packet consists of a header, which contains information necessary for sending/receiving, and data section which is the data itself.

Password

A character string which must be entered by a user who is accessing a network because of network security. If a password is set, the user cannot access unless the user enters the valid password correctly.

Patch Cable

The transmission signal cable and receiving signal cable are wired straight to communicate correctly. Generally used for connection between the PC and HUB.

Protocol

Definition of procedure to execute send/receive data in the communication.

Subnet mask

A subnet mask is used in one IP address as a network address and host address. Assuming that the IP address of a host is "192.168.0.1" and the subnet mask is "255.255.255.0" multiply the IP address of binary notation and subnet mask of binary notation together, and the network address "192.168.0.0" is obtained. Then, the remainder "1" is the host address.

Traffic

Flow of packets on the network or load applied to the network line (e.g., data transmitted through the network line). As the traffic increases, the data transmission rate may decrease or data may be lost.

WEP (Wired Equivalent Privacy)

A function to encrypt, send and receive a wireless LAN signal. This function can prevent wireless LAN communication interception.

10BASE-T

One of the Ethernet standards. 10BASE-T achieves the transmission rate of 10 Mbit/s with a twisted pair cable.

100BASE-TX

One of the Ethernet standards. 100BASE-TX achieves the transmission rate of 100 Mbit/s with a twisted pair cable of Category 5.

Count on us!